

Barkbusters

www.barkbusters.net

FITTING INSTRUCTIONS for STM-005 with Aluminium Backbone for Hollow Handlebar

LEFT SIDE

Item (12) orientate with chamfer to the handlebar.

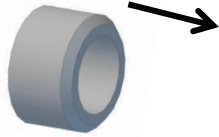

Optional Parts - Sold Separately
For 1 inch hollow handlebars -
Order Code: **B-074**

NOTE:

- 12 - use when extra grip clearance is required
- 11 - use with larger internal diameter bars up to 18.5mm ID as required

NOTE:

Many HONDA models have a rubber mounted, internal threaded bar weight. Both original external and internal bar weights must be removed, to leave a hollow handlebar, for correct fitment of handguard..

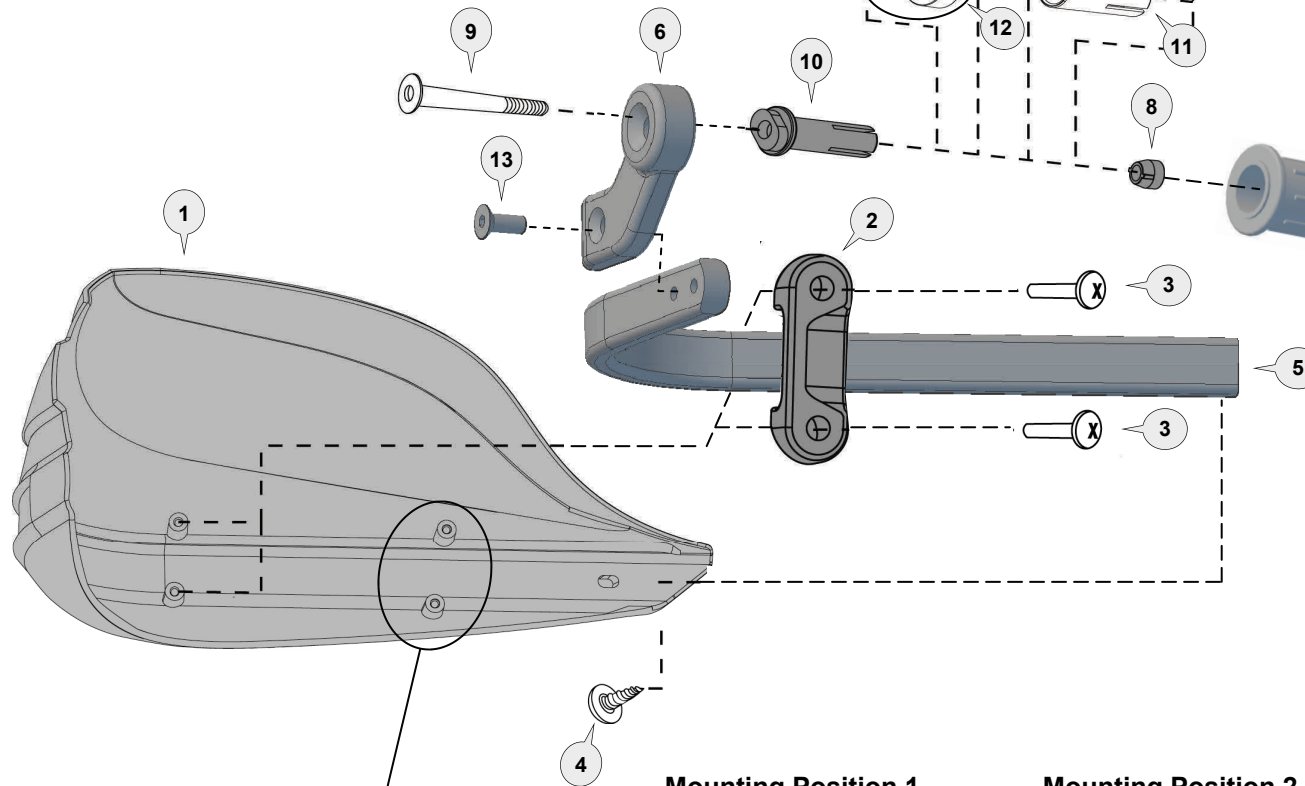

Not used in this application

Mounting Position 1

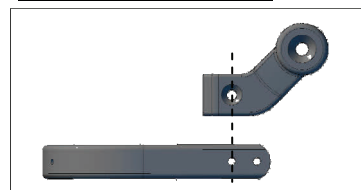

Mounting Position 2

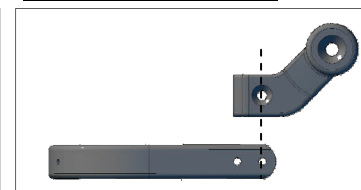

1 Storm Plastic



PN: SP1
Pcs. 1 Left & 1 Right

2 Saddle



PN: Storm-Saddle
Pcs. 2

3 Mush Head Screw



PN: SCREWPT3.5x14
Pcs. 4

4 Black Screw



PN: STSZ811MX11
Pcs. 2

5 Aluminium Bar (Black)



PN: BAR-S-011
Pcs. 2

6 Bar End LEFT



PN: BE-ST-L
Pcs. 1

7 Bar End RIGHT



PN: BE-ST-R
Pcs. 1

8 Taper Nut



PN: NUT12
Pcs. 2

9 Flat Head Bolt 75mm

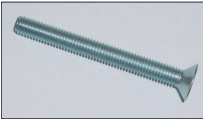

PN: M8x75FHCSZP-FT
Pcs. 2

10 Inner Collet



PN: ICL
Pcs. 2

11 Collet



PN: : COLLET14-17
Pcs. 2

12 Spacer



PN: SP12-21-14
Pcs. 2

13 Flat Head Bolt 16mm



PN: : M6x16FHCSZP-DL
Pcs. 2

Personalise Your Protection
Guard options sold separately

JET JET-003
VPS VPS-003
Storm STM-003
CARBON BCF-003

Recommended Torque Settings	
M6	10 Nm (7.4 lbf ft)
M8	20 Nm (14.8 lbf ft)

NOTE:
Thread lock on bolts is for single use ONLY.
If reinstalling, apply new thread lock.

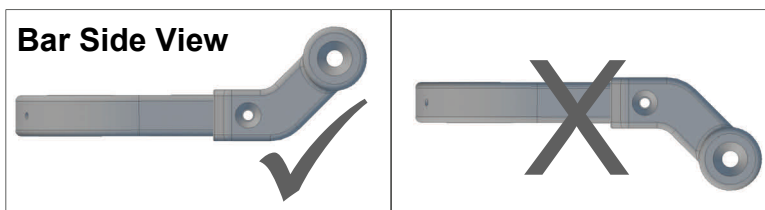

CAUTION:

Installation of the handguard is safety-relevant work and can be complicated. We recommend the installation be performed by a motorcycle service technician. Rideworx accepts no liability for damages caused by improper mounting. All screws, bolts and nuts, including all replacement hardware provided by Rideworx, should be tightened to the torque specified in the table. After the first 50km of riding check all screws, bolts and nuts are tightened to the correct torque. We recommend a medium strength liquid thread lock product on all fasteners.

WARNING:

Check operation of all handlebar controls, specifically the throttle, front brake, kill switch and clutch to ensure they are operating correctly and are in accordance with the OEM specifications. Do not ride the motorcycle if any controls are not operating correctly. Check periodically that all bolts are tight.

Disclaimer:

A failure to follow these fitting instructions could cause serious injury, death or property damage. These handguards are intended solely for use with motorcycles/ATV/snowmobiles/scooters that have not been modified. They are not designed to prevent injury or death while riding or in an accident or crash. The user must ensure that all controls are free of the handguards every time that they ride. By installing and/or using this product you acknowledge that you accept these terms and have followed the fitting instructions.



Phone: +61 (0)2 4271 8244
Email: info@barkbusters.net
Web: www.barkbusters.net

