



Custom Dynamics® UTV Turn Signal Kit Installation Instructions

We thank you for purchasing the Custom Dynamics® UTV LED Turn Signal Kit. Our products utilize the latest technology and high quality components to ensure you the most reliable service. We offer one of the best warranty programs in the industry and we back our products with excellent customer support, if you have questions before or during installation of this product please call Custom Dynamics® at 1(800) 382-1388.

Part Number: CD-UTV-TS-KIT

Package Contents: (See Photo pg. 2)

- Amber LED Turn Signals (4)
- Turn Signal Indicators (2)
- Flasher Relay/Switch Harness (1)
- Diode Harness Cable (1)
- 4 Way Hazard Switch
- Ground Cable (1)
- CAN Adapter (2)
- 9" Tie Wraps (25)
- Blue Wire Taps (4)
- Blue Butt Connectors (2)
- 5 Position Cage Clamps (3)

Fitment: Universal fitment for UTV's requiring turn signals and 4-way hazards for on-road use.



ATTENTION

Please read all Information below before Installation

Warning: Disconnect negative battery cable from battery; refer to owner's manual. Failure to do so may result in electrical shock, injury, or fire. Secure negative battery cable away from positive side of battery and all other positive voltage sources on vehicle.

Safety First: Always wear appropriate safety gear including safety glasses when performing any electrical work. It is highly recommended that safety glasses be worn throughout this installation process. Be sure vehicle is on level surface, secure and cool.

Important: Some wiring knowledge will be needed for this installation. Consult your vehicle detailed service manual for wiring information and color codes. Use a meter or test light to verify wiring before cutting or tapping any vehicle wiring. If the steps contained within are beyond your skillset, do not attempt installation, contact a qualified mechanic or dealership to assist you.

Note: This kit is designed for universal fitment. The following instructions show installation on a specific Polaris model that may vary in construction, location of controls and features compared to yours. You should note the following for reference only. Ultimately, it is up to you to find the best locations for the devices, the best routes for the wiring and make sure that they do not interfere with any mechanical parts on the vehicle. Make sure they cannot be pinched, cut or frayed. Failure to do so can result in damage to the vehicle, the product or yourself.

Tools Needed for Installation

- Drill
- 3/8" Drill bit
- 1 3/8" (35 mm) hole saw
- Dremel tool
- Wire Cutters/strippers
- Electrical Stake-on Pliers
- Center Punch
- Measuring tape
- Vehicle Service Manual

Installation

- 1** Un-pack the contents of the kit. Use the photo diagram on page 2 to verify all parts are present.

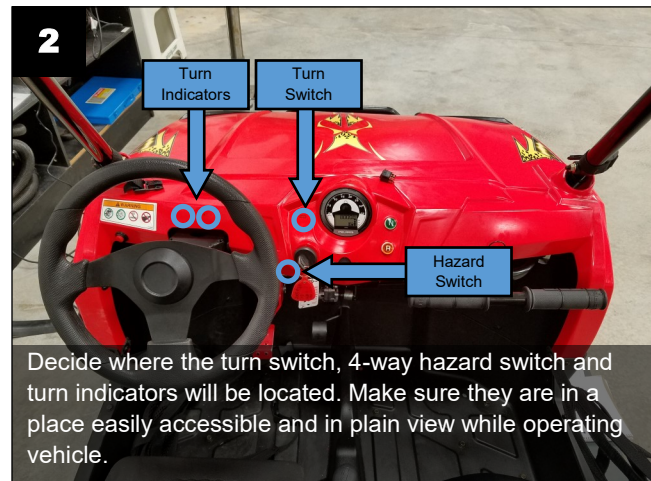

2 Decide where the turn switch, 4-way hazard switch and turn indicators will be located. Make sure they are in a place easily accessible and in plain view while operating vehicle.

- 3** To ensure the turn indicators and hazard switch are level and centered, use a tape measure to find the desired location, then mark with a pen or pencil. Use a center punch at each marking to create a guide for the drill bit.

- 4** The hole for the turn switch will need to cut out with a Dremel tool. Mark a 1/2" x 9/16" area with pen or pencil.

Instructions continued on page 3

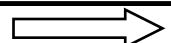

Kit Parts List - Page 2



- 1- Amber LED Turn Signals X4
- 2- Turn Signal Indicators X2
- 3- Turn Signal Relay Harness w/Switch
- 4- Diode Harness
- 5- 4-Way Hazard Switch
- 6- Ground Cable

- 7- Car Adapter X2
- 8- Tie Wraps X25
- 9- Wire Taps X4
- 10- Butt Connectors X2
- 11- 5 position Cage Clamps X3

CD-JTV-TS-KIT - Parts List



Custom Dynamics, LLC
 15 Cypress Drive
 Youngsville, NC 27596 USA
 Phone: (800) 382-1388

Installation Instructions - Page 3

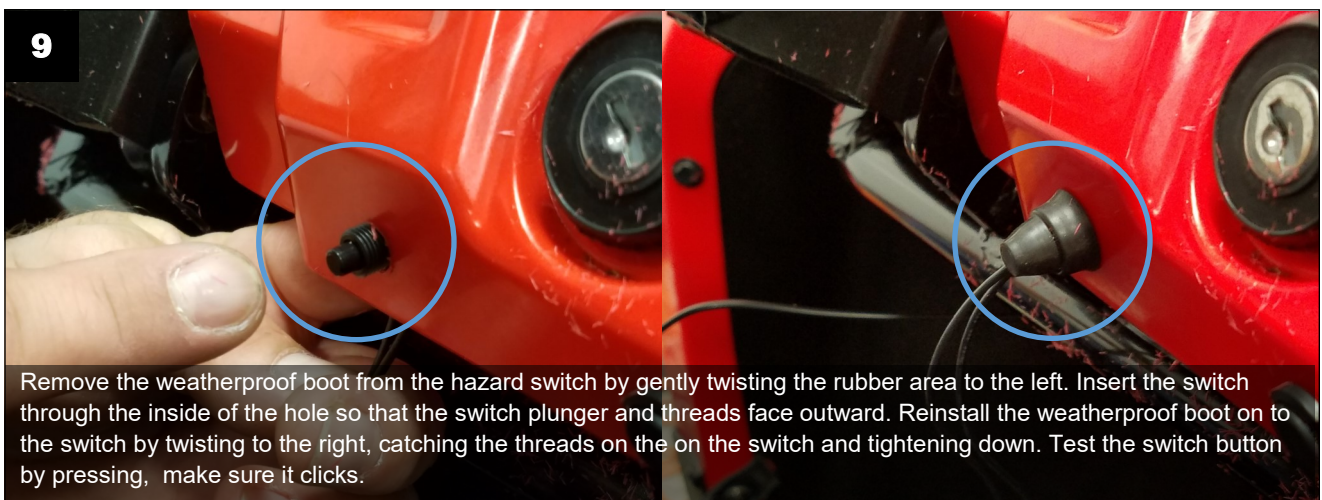
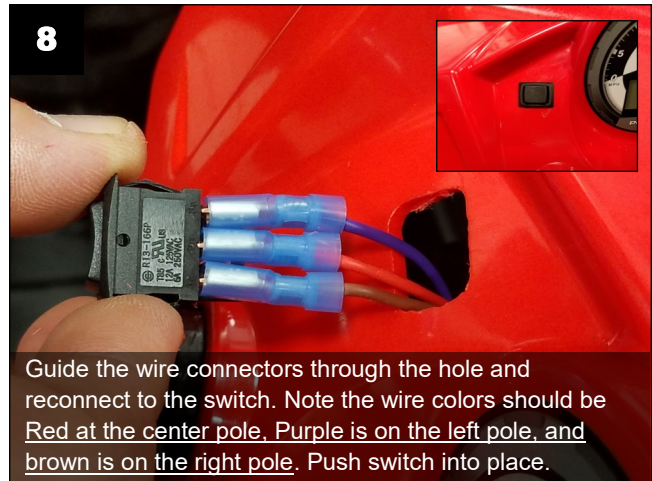
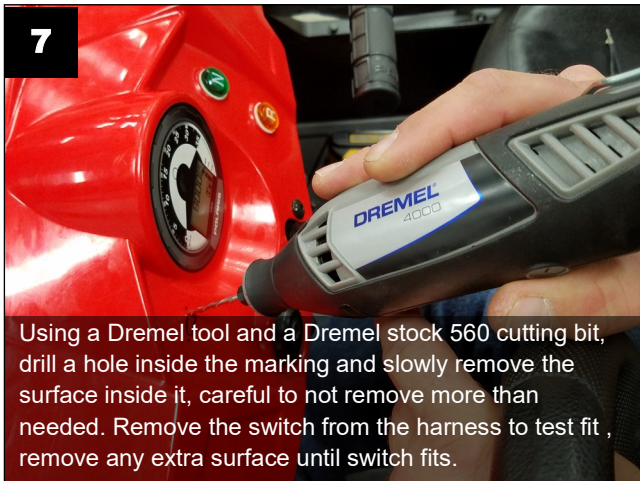
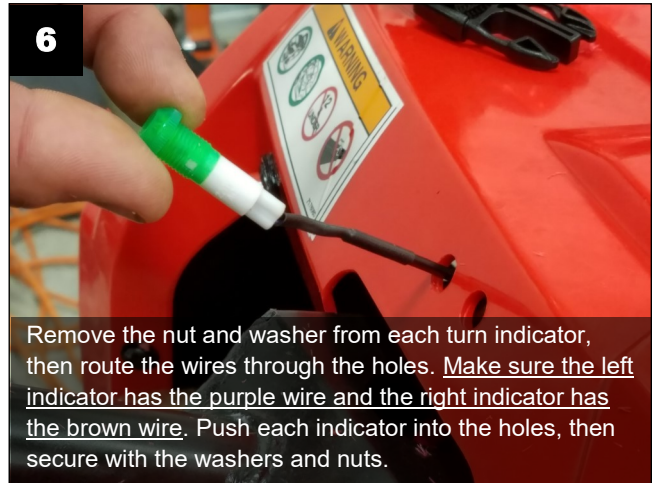

Installation Instructions - Page 4

10

Note: model shown has faux brake decals in location chosen for installation.



Decide where each Rear Turn signal will be mounted. The turn signal housings need a minimum of 1.8 inches of flat surface to properly mount. Note that the turns should be as far out to the corners as possible.

11



Measure the locations with a measuring tape, then mark the location of the center hole with a center punch. Note that the diameter of the LED & gasket combined are 1.8 inches in diameter.

12



Using a drill and a 1 3/8 inch (35 mm) hole saw, find the center punch hole at the location, then drill the hole through the body. Repeat for the other side.

13

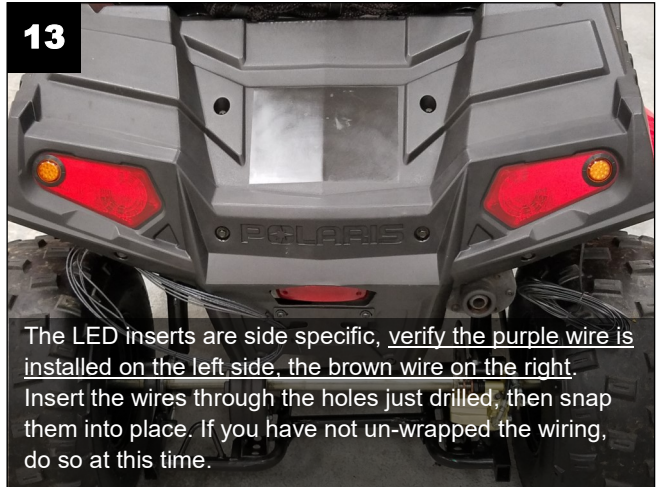

The LED inserts are side specific, verify the purple wire is installed on the left side, the brown wire on the right. Insert the wires through the holes just drilled, then snap them into place. If you have not un-wrapped the wiring, do so at this time.

14

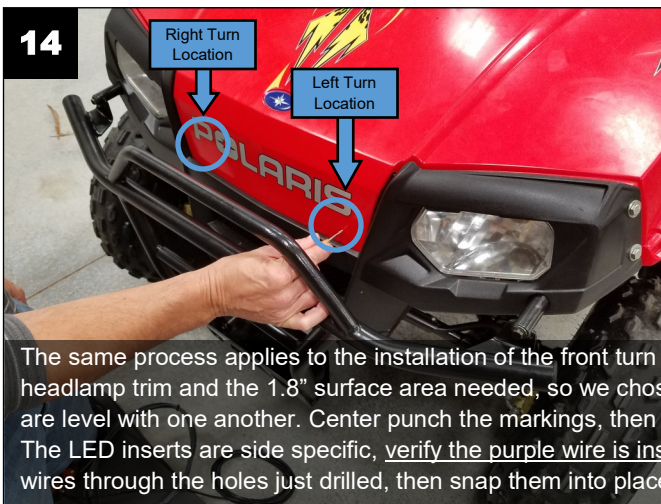

The same process applies to the installation of the front turn signals. We were limited in areas to mount them given the headlamp trim and the 1.8" surface area needed, so we chose the location shown. Measure the distances to ensure they are level with one another. Center punch the markings, then drill with the 1 3/8 inch (35mm) hole saw. Remember that The LED inserts are side specific, verify the purple wire is installed on the left side, the brown wire on the right. Insert the wires through the holes just drilled, then snap them into place. If you have not un-wrapped the wiring, do so at this time.

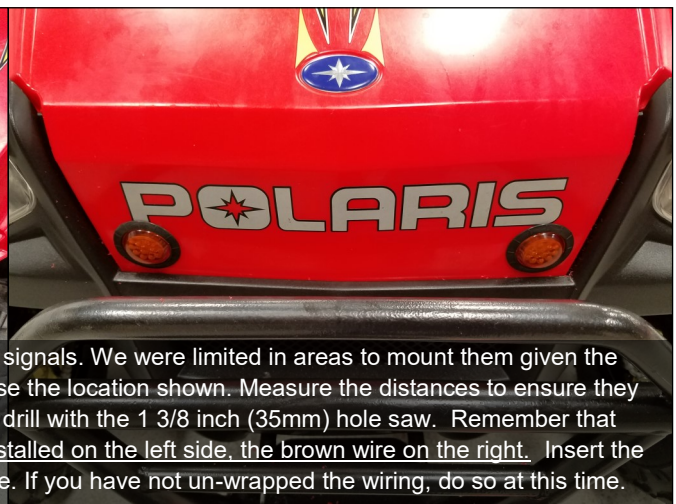

Installation Instructions - Page 5

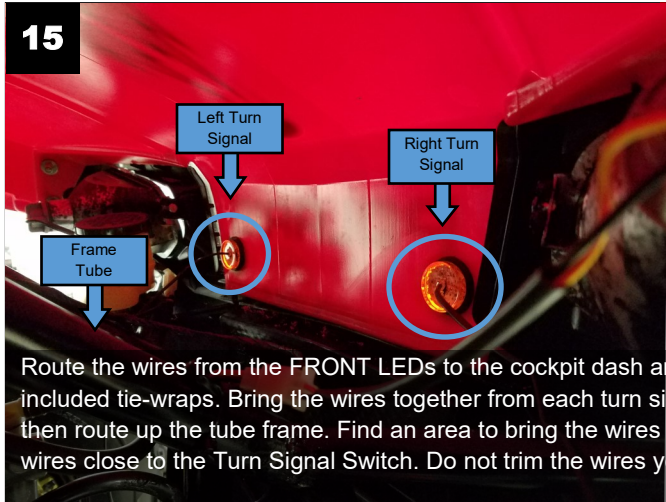

Route the wires from the FRONT LEDs to the cockpit dash area. Utilize the frame tubing to attach them with the included tie-wraps. Bring the wires together from each turn signal to one side of the vehicle (photos show the right side), then route up the tube frame. Find an area to bring the wires into the cockpit. Once near the dash area, route and secure wires close to the Turn Signal Switch. Do not trim the wires yet.

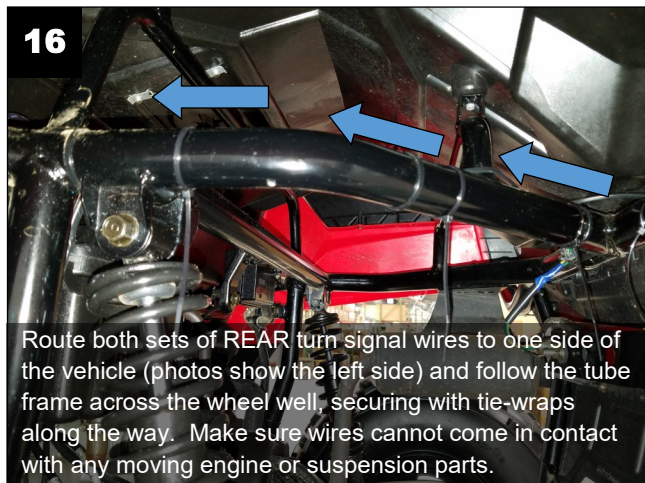
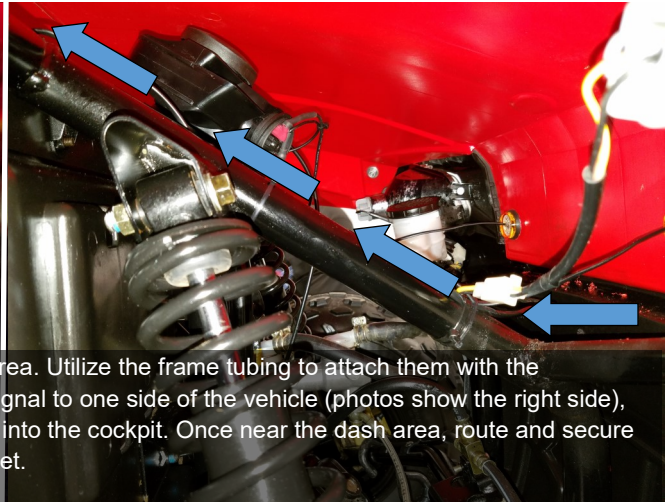

Route both sets of REAR turn signal wires to one side of the vehicle (photos show the left side) and follow the tube frame across the wheel well, securing with tie-wraps along the way. Make sure wires cannot come in contact with any moving engine or suspension parts.

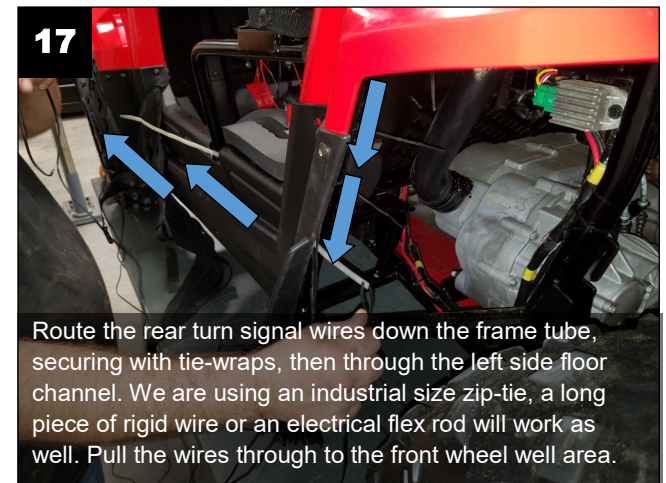

Route the rear turn signal wires down the frame tube, securing with tie-wraps, then through the left side floor channel. We are using an industrial size zip-tie, a long piece of rigid wire or an electrical flex rod will work as well. Pull the wires through to the front wheel well area.

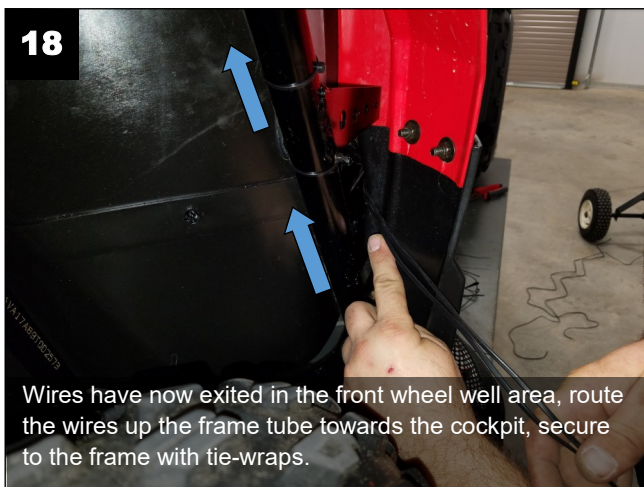

Wires have now exited in the front wheel well area, route the wires up the frame tube towards the cockpit, secure to the frame with tie-wraps.

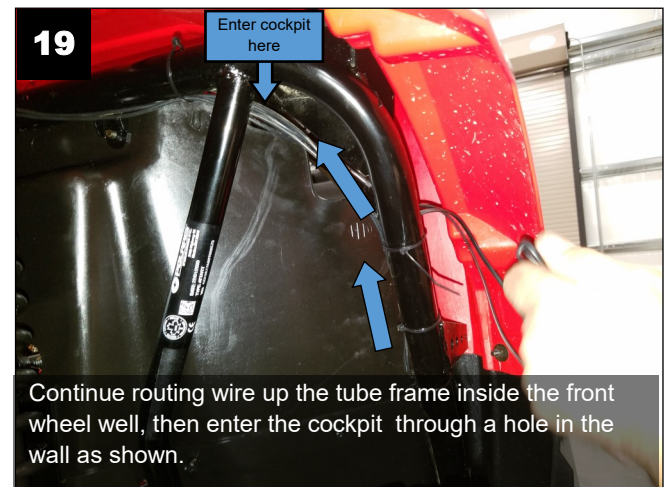

Continue routing wire up the tube frame inside the front wheel well, then enter the cockpit through a hole in the wall as shown.

Installation Instructions - Page 6

20

With all of the Turn signal wires inside the cockpit, measure the wires from the secure point on the frame to about 15-18 inches. This measurement should allow the wires to reach the brake pedal. Cut all for pairs of wires, then strip back the insulation using a pair of wire strippers. This wire length allows us to create what we call a "Service Loop". We will also wire in the turn signal relay harness and the diode harness in this loop. Further explanation of the loop will come shortly.

21

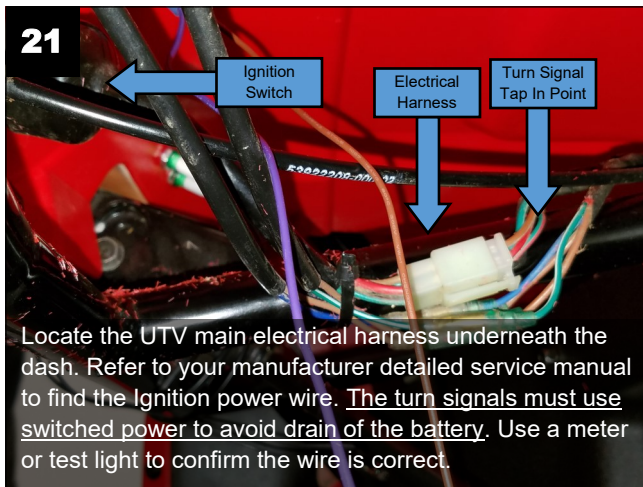

22

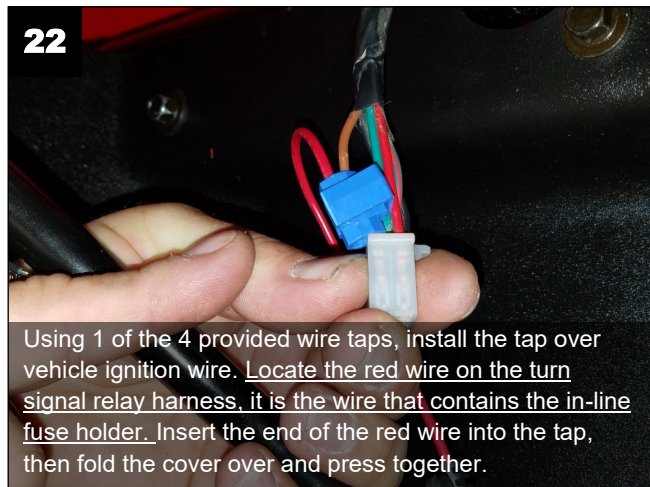

23

Referencing the wiring diagram at the right, Identify the ORANGE wire on the Turn Signal Relay Harness. Using the provided blue butt connector, insert the orange wire end into one side of the butt connector, then crimp the connector with a pair of electrical stake-ons. Next, Insert one of the 4-way hazard switch's black wire ends into the other end of the butt connector. It does not matter which wire is chosen on the switch. Crimp the butt connector with the stake-ons, then perform a light pull test on both wires to ensure they are properly connected.

24

Referencing the wiring diagram at the right, Identify the RED wire on the Diode harness. Using the other provided blue butt connector, insert the RED wire end from the Diode harness into one side of the butt connector, then crimp the connector with the stake-ons. Next, Insert the other black wire from the hazard switch into the other end of the butt connector. Crimp the butt connector with the stake-ons, then perform a light pull test on both wires to ensure they are properly connected.

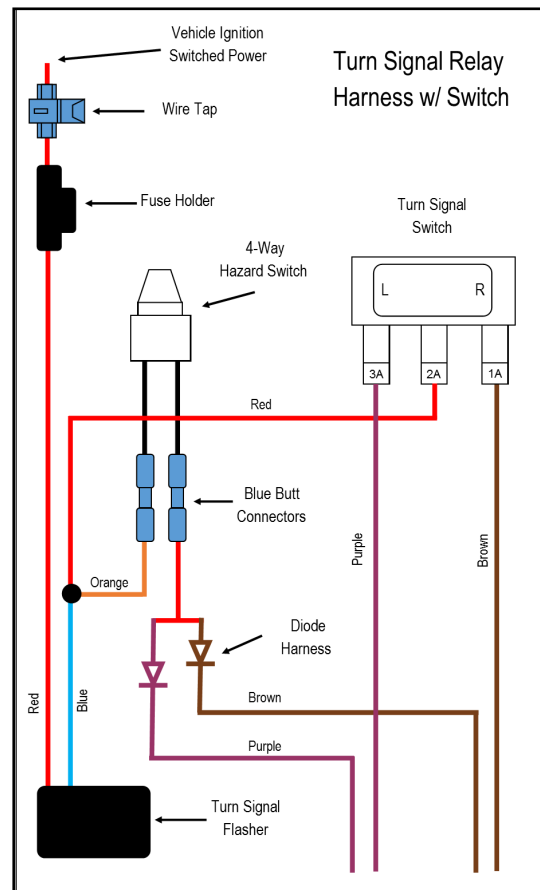

Installation Instructions - Page 7

25

The main harness is now assembled, trim the remaining harness wires to the length of the LED turn signal wires were cut earlier. Strip back the insulation on all wires in preparation for the next step.

26

Using the provided Cage clamp connectors, label them 1, 2 & 3. Referencing the diagram on page 8, cage clamp number 1 will be assigned to all of the Left turn PURPLE wires. Cage Clamp 2 will be assigned to all of the Ground BLACK wires. Cage Clamp number 3 will be assigned to all of the Right turn Brown wires.

27

Gather all of the positive PURPLE (Left turn signal) colored wires and insert them into the number 1 Left turn cage clamp. To insert, pull the orange lever lock up, insert the wire, then close the lever lock. You will need to twist a couple of the PURPLE wires together before inserting into the cage clamp, in order to fit all the wires.

28

Gather all of the negative ground BLACK colored wires and insert them into the number 2 Ground cage clamp. To insert, pull the orange lever lock up, insert the wire, then close the lever lock. You will need to twist a couple of the BLACK wires together before inserting into the cage clamp, in order to fit all the wires.

29

Using the provided Ground Cable, insert the wire end of the cable into the number 2 Ground cage clamp. Locate a suitable ground stud on the vehicle to attach the ring connector. Refer to the vehicle's detailed service manual if unsure of this location.

30

Gather all of the positive BROWN (Right turn signal) colored wires and insert them into the number 3 Right turn cage clamp. To insert, pull the orange lever lock up, insert the wire, then close the lever lock. You will need to twist a couple of the BROWN wires together before inserting into the cage clamp, in order to fit all the wires.

31

Using one of the provided CAN-Adapters, Install the orange wire end into one of the slots of the number 1 Left turn cage clamp. Install the black wire end of the adapter into the number 2 Ground cage clamp.

32

Using the remaining provided CAN-Adapter, Install the orange wire end into one of the slots of the number 3 Right turn cage clamp. Install the black wire end of the adapter into the number 2 Ground cage clamp.

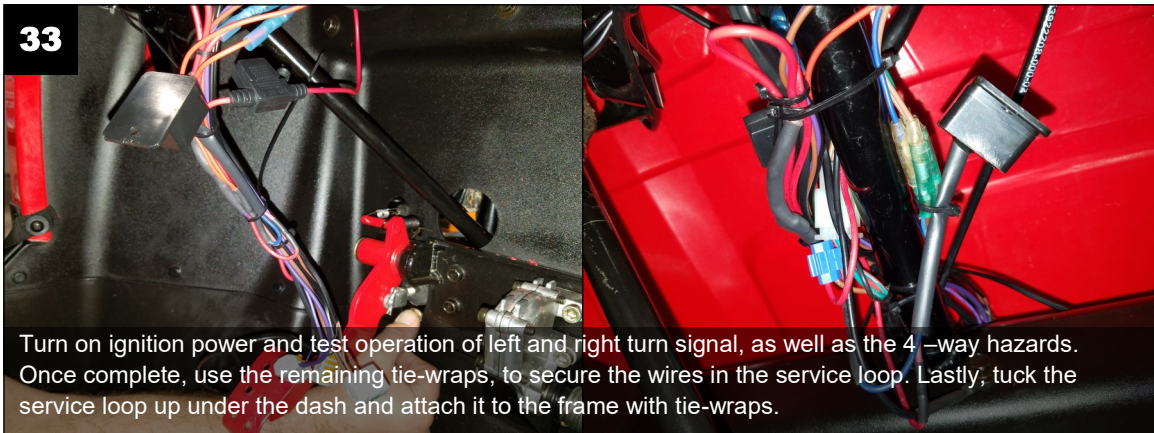

Wiring Diagram - Page 8

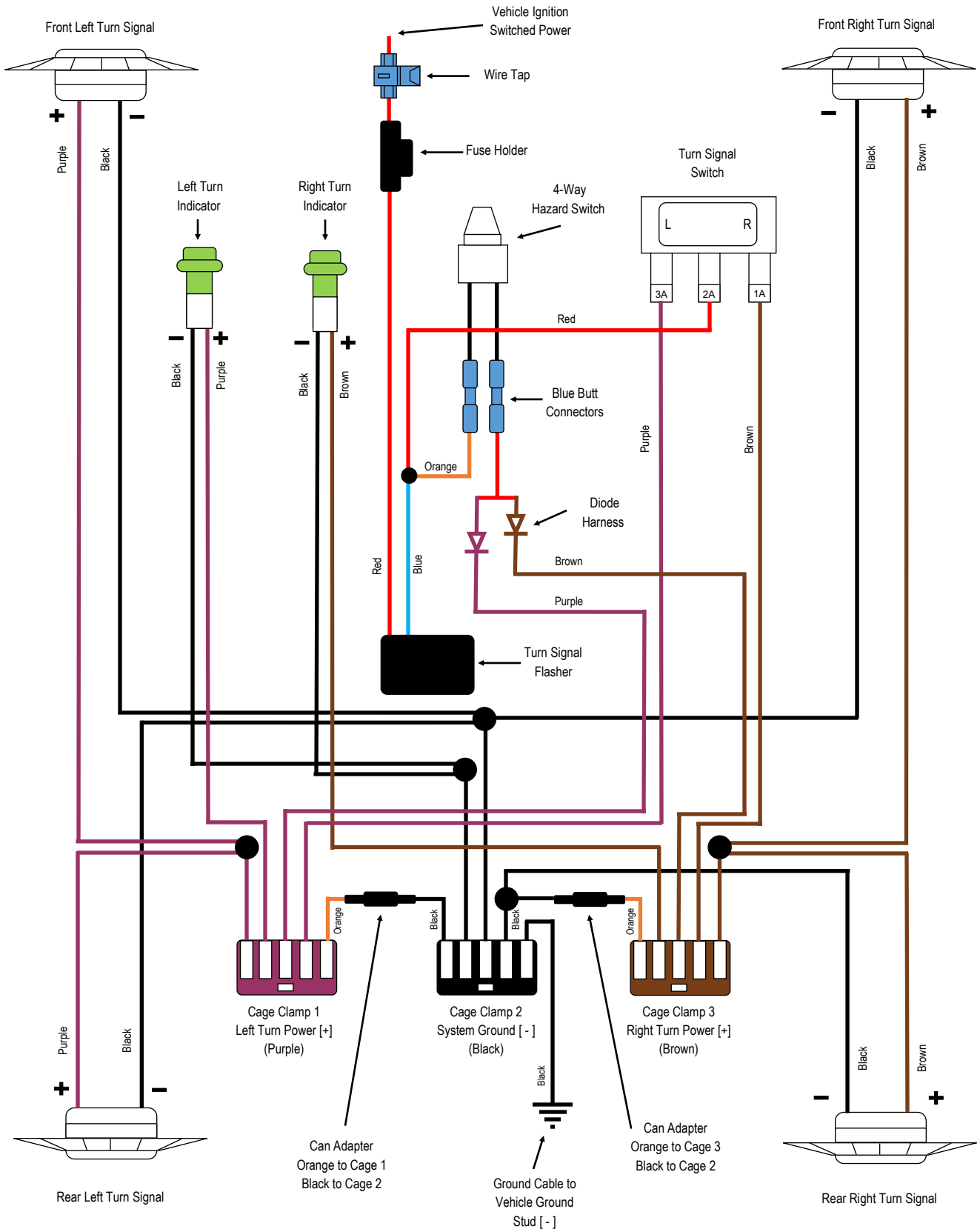

Questions? Call us at: 1 (800) 382-1388 M-TH 8:30AM-5:30PM / FR 9:30AM-5:30PM EST