

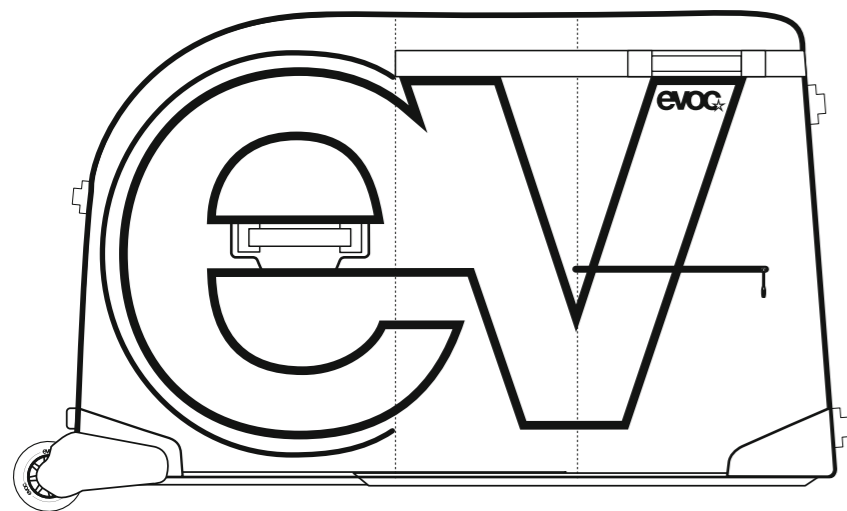

PROTECTIVE SPORTS PACKS



INSTRUCTION MANUAL
FOR PACKING
A MOUNTAINBIKE OR ROADBIKE IN YOUR
BIKE BAG

ENCLOSED PARTS

- 4x WHEELCASE TUBES
- 2x FRONT STICKS (A)
- 2x REAR STICKS (B)
- 1x BIKE BLOCK
- 2x WEBBING LOOPS
- 1x FRAME PAD

TOOLS NEEDED

- PEDAL WRENCH
- ALLEN KEY

BIKE TRAVEL BAG

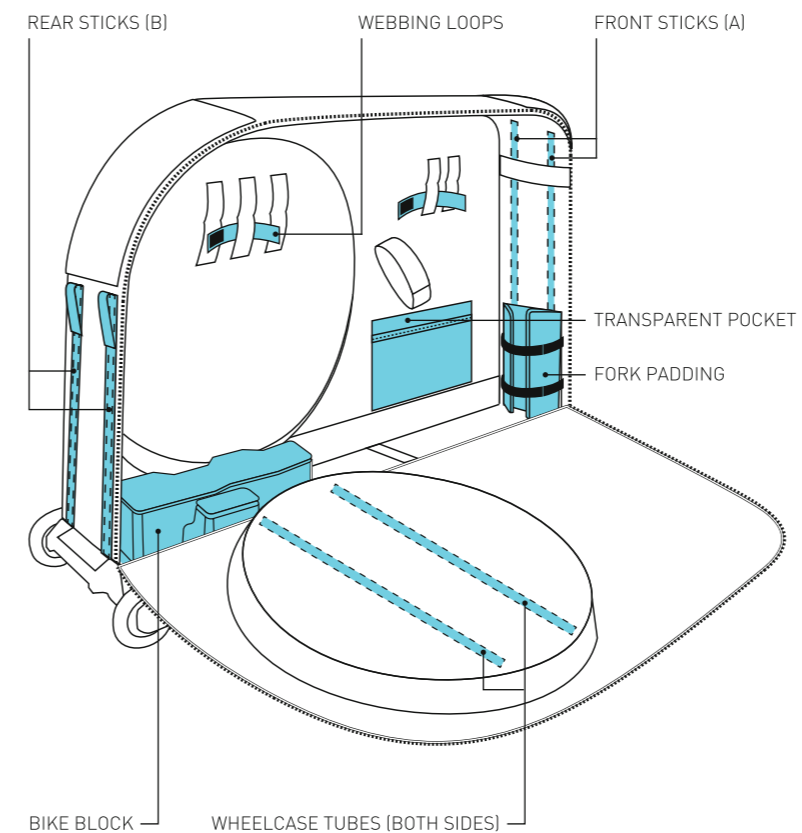

HOW TO ASSEMBLE YOUR BIKE TRAVEL BAG PRO

// 01

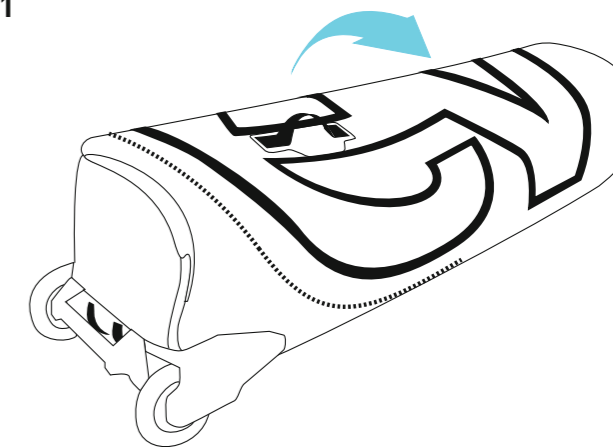

// 02

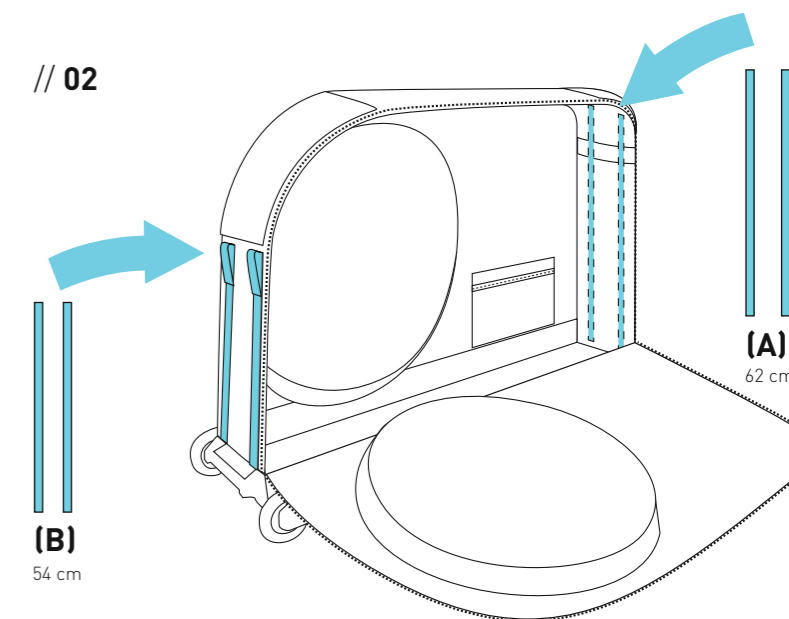

BIKE TRAVEL BAG

// 03

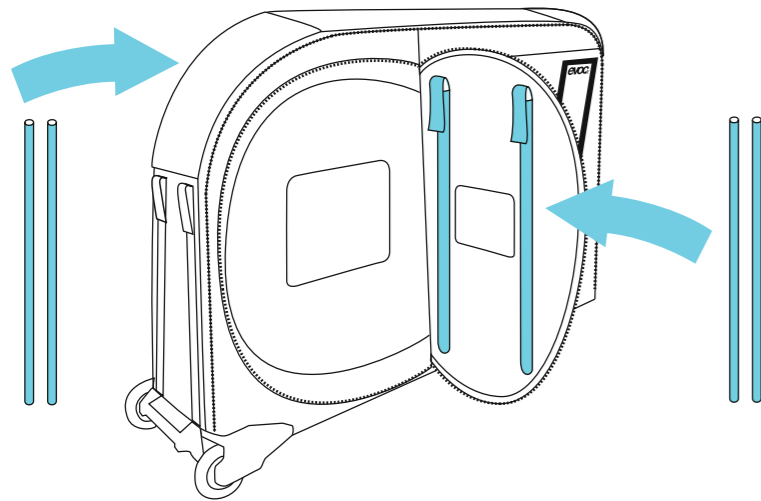

// 04

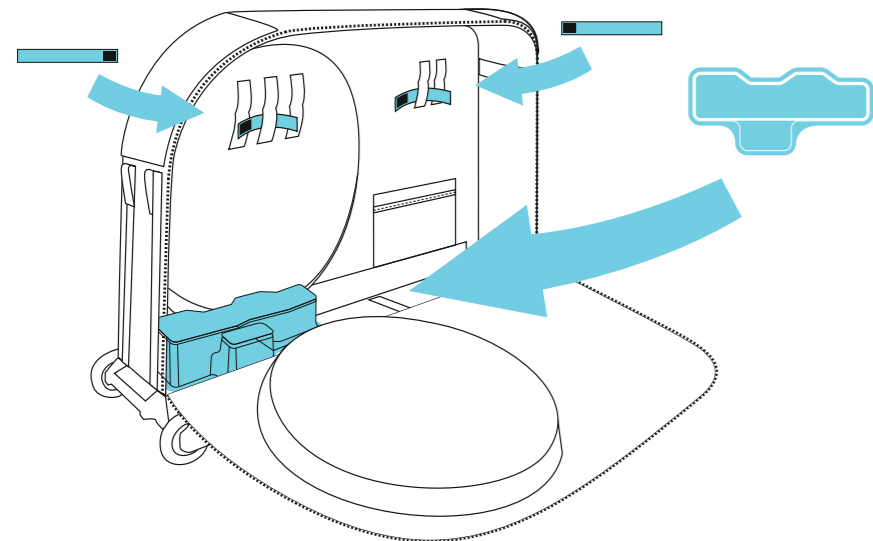

BIKE PREPARATION

// 05

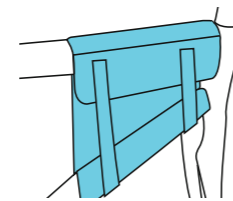

Add FRAME PAD

// 06

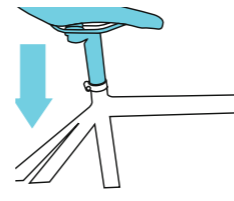

Lower in your bicycle saddle

// 07

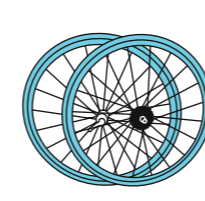

Remove both wheels

// 08

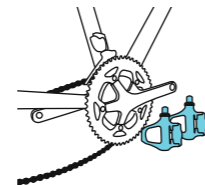

Remove both pedals

// 09

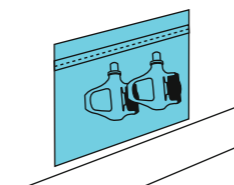

Put pedals in transparent pocket

// 10

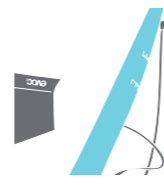

Remove handle bar

// 11

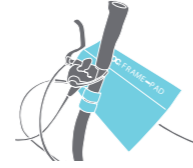

Fix bar to FRAME-PAD

// 12

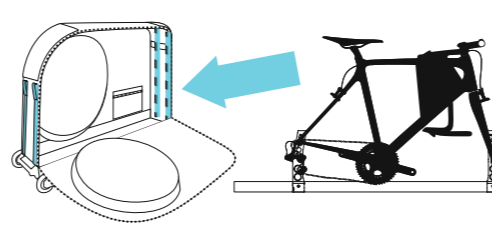

Place your bike in the BIKE BAG PRO

// 13

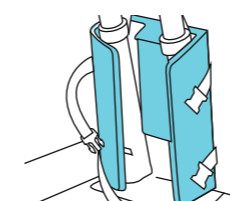

Put fork into FORK PADDING

// 14

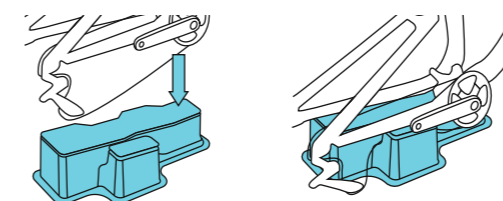

Position bottom bracket on BIKE BLOCK

// 15

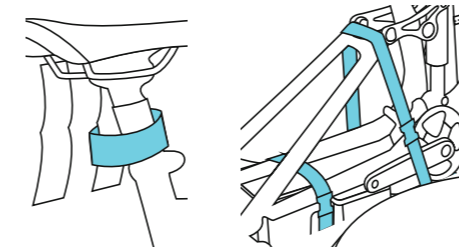
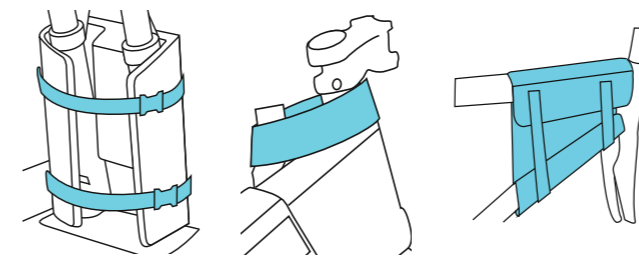

Fix your bike with red straps

BIKE TRAVEL BAG

// 17

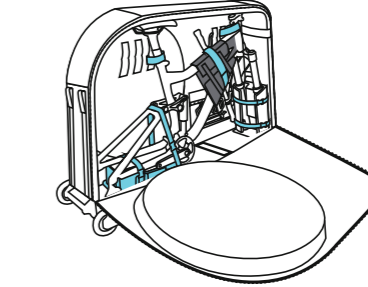

Looks like this? Almost done!

// 18

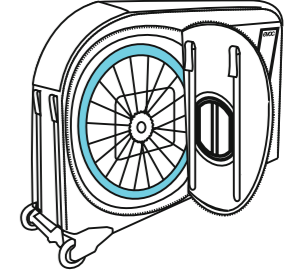

Don't forget to put wheels in wheel compartment

WARRANTY AND AFTER SALES SERVICE



WARRANTY
www.evocsports.com/service/warranty