

IN2132KIT - IN2132KIT

KIT SPECIFICO - SPECIFIC KIT - KIT SPECIFIQUE - SPEZIFISCHES KIT - KIT ESPECÍFICO

YAMAHA MT-09 (2017)

N°	Descrizione	Caratteristiche	Codice	Quantità
1	Supporto - Support - Support Halterung - Soporte - Apoio	-	GL1657V	1
2	Anelli - Rings - Bagues - Anillos - Ringe - Anel	-	GL629V	2
3	Vite - Screw Vis - Schraube Tornillo - Parafuso	TBEI M6x50	650TBEI	2
4	Vite - Screw Vis - Schraube Tornillo - Parafuso	TEN M6x12	612TEN	2
5	Rondella - Washer Rondelle - Scheibe Arandela - Arruela	-	Z1063	2
6	Distanziale - Spacer Entretoise - Distanzstueck Distanciador - Espaçador	Ø15x30 Foro 6,5	C15L30F6,5T	2
7	Componenti Originali - Original Parts Parties Originales - Original Bauteile Componentes Originales - Componentes Originais	-	-	-
8	Connettore maschio - Male connector - Connecteur mâle - Conector macho - Stecker männlich - Plugue macho	-	Z2424	4
9	Connettore femmina - Female connector - Connecteur fe- melle - Conector hembra - Stecker weiblich - Plugue fêmea	-	Z2425	4
10	Prolunga - Extension cord - Rallonge électrique - Cable de extensión - Verlängerungskabel - Cabo de extensão	-	Z2426	2

IN2132KIT - IN2132KIT

KIT SPECIFICO - SPECIFIC KIT - KIT SPECIFIQUE - SPEZIFISCHES KIT - KIT ESPECÍFICO

YAMAHA MT-09 (2017)

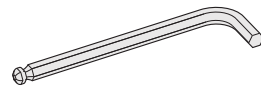
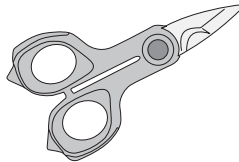
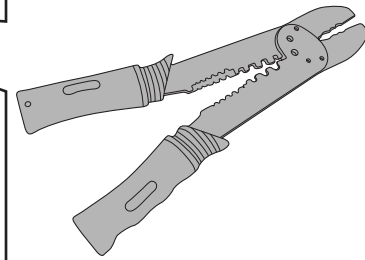
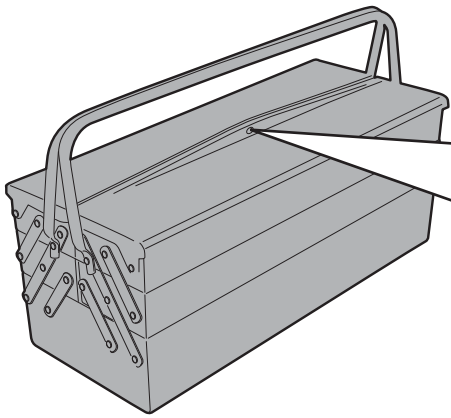
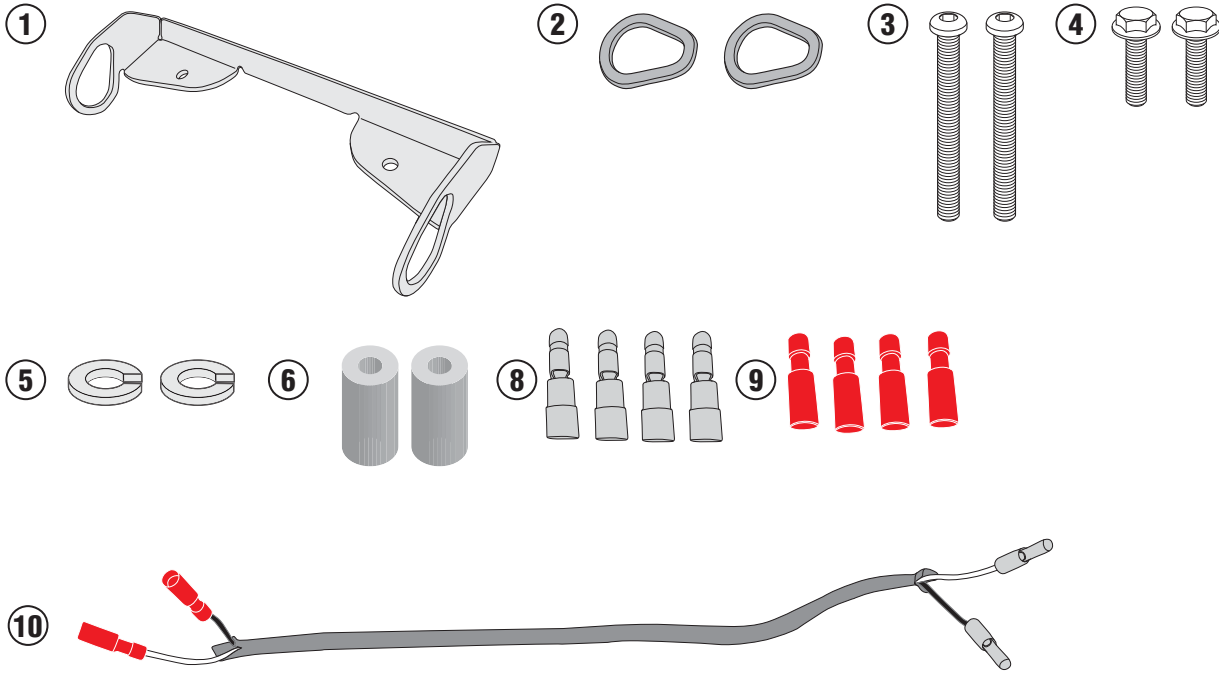

4mm

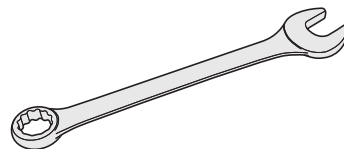

10mm



IN2132KIT - IN2132KIT

KIT SPECIFICO - SPECIFIC KIT - KIT SPECIFIQUE - SPEZIFISCHES KIT - KIT ESPECÍFICO

YAMAHA MT-09 (2017)

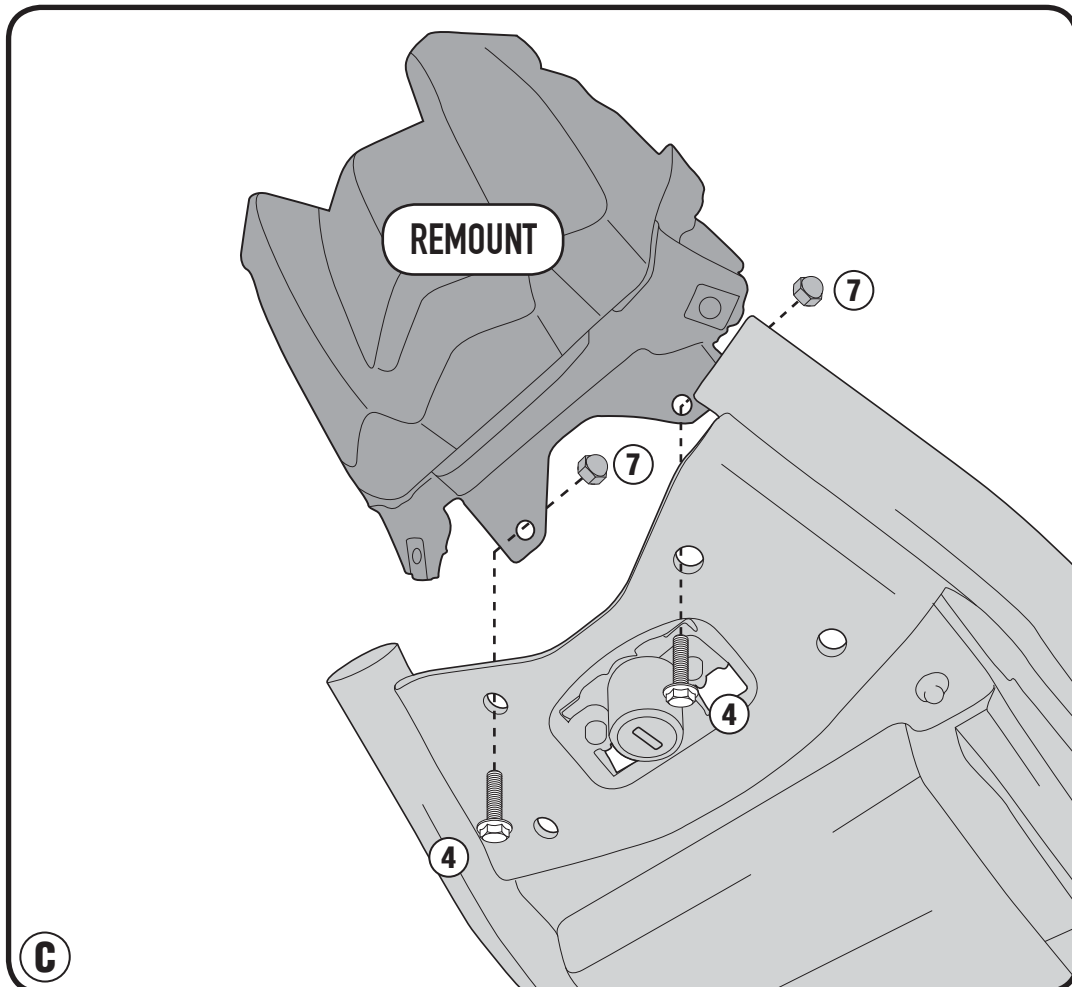
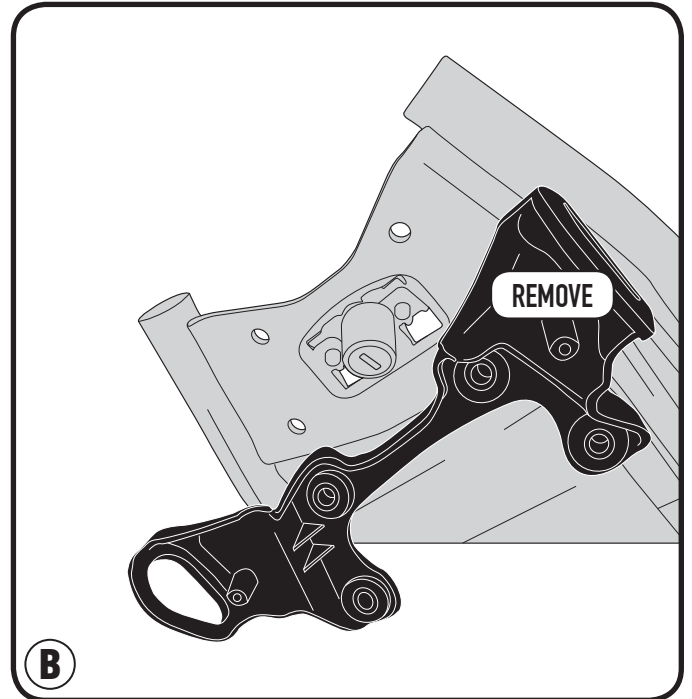
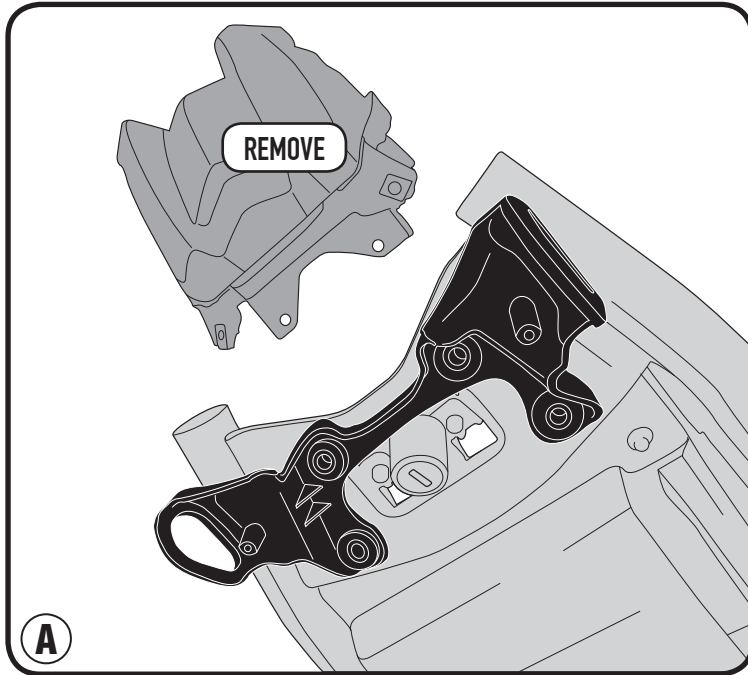

IN2132KIT - IN2132KIT

KIT SPECIFICO - SPECIFIC KIT - KIT SPECIFIQUE - SPEZIFISCHES KIT - KIT ESPECÍFICO

YAMAHA MT-09 (2017)

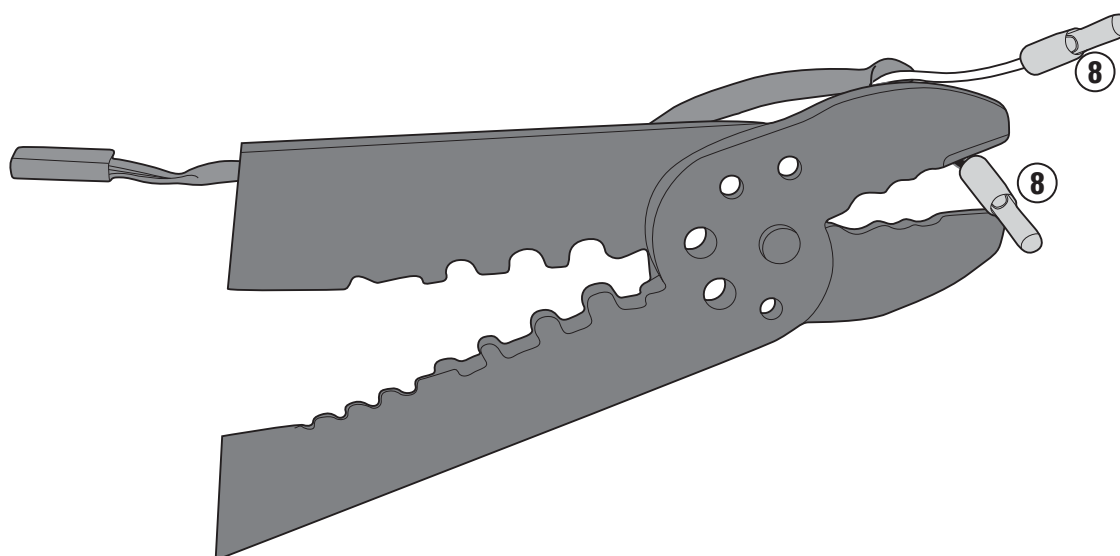
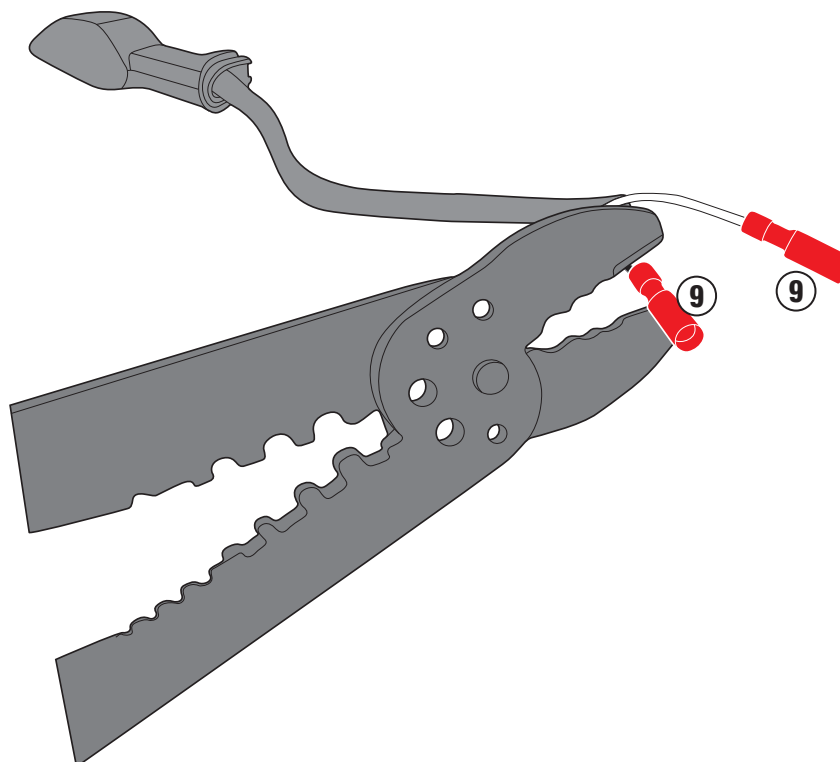
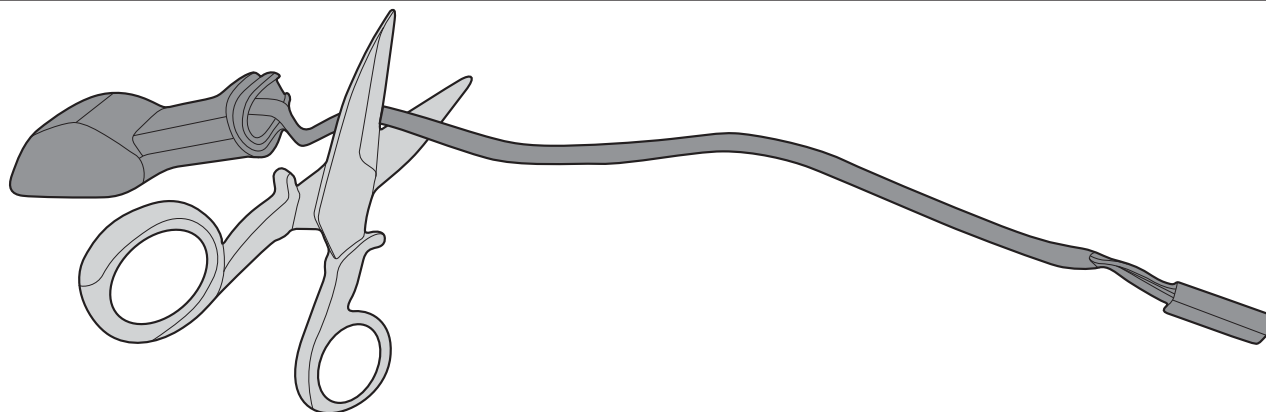

IN2132KIT - IN2132KIT

KIT SPECIFICO - SPECIFIC KIT - KIT SPECIFIQUE - SPEZIFISCHES KIT - KIT ESPECÍFICO

YAMAHA MT-09 (2017)

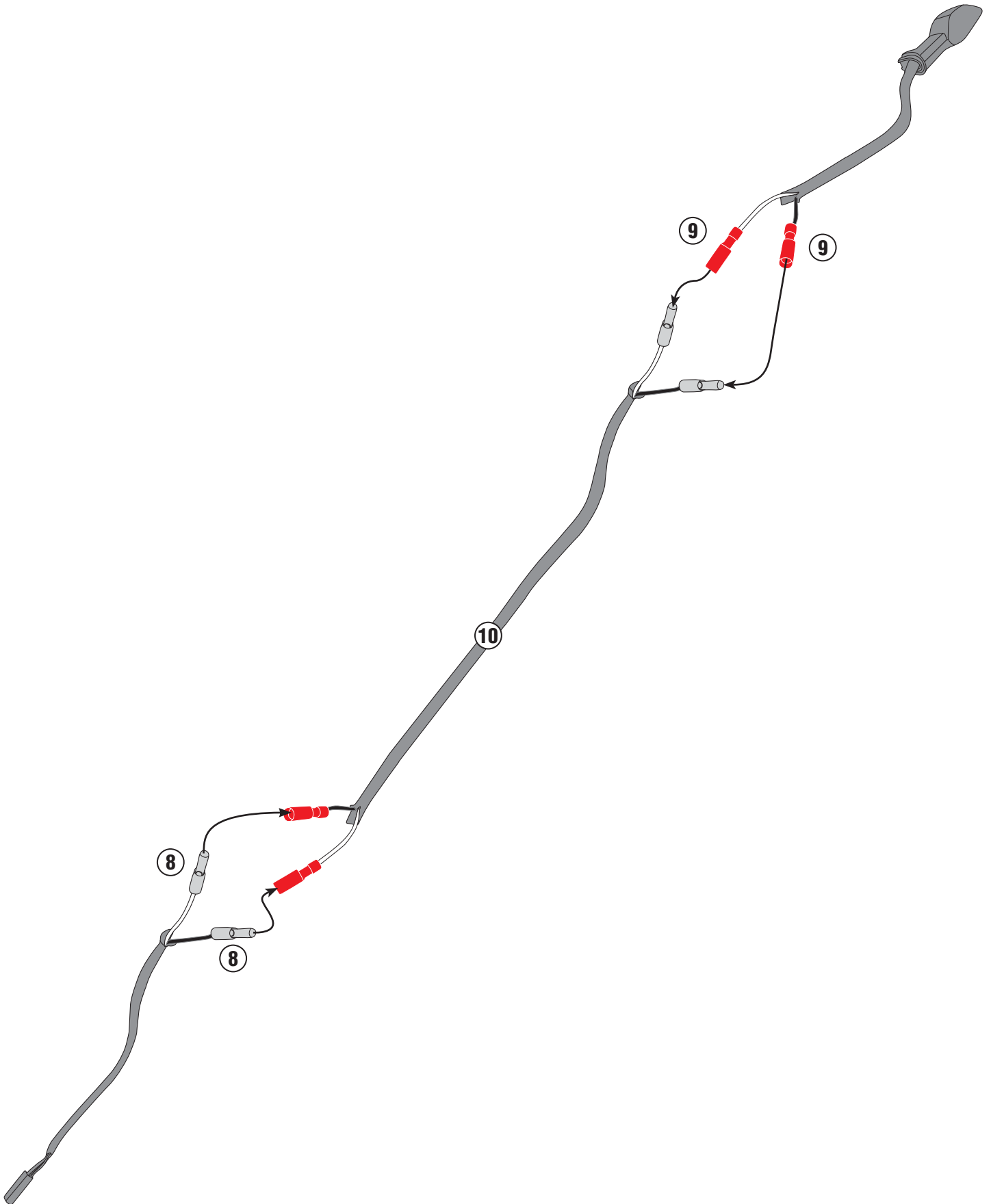

IN2132KIT - IN2132KIT

KIT SPECIFICO - SPECIFIC KIT - KIT SPECIFIQUE - SPEZIFISCHES KIT - KIT ESPECÍFICO

YAMAHA MT-09 (2017)

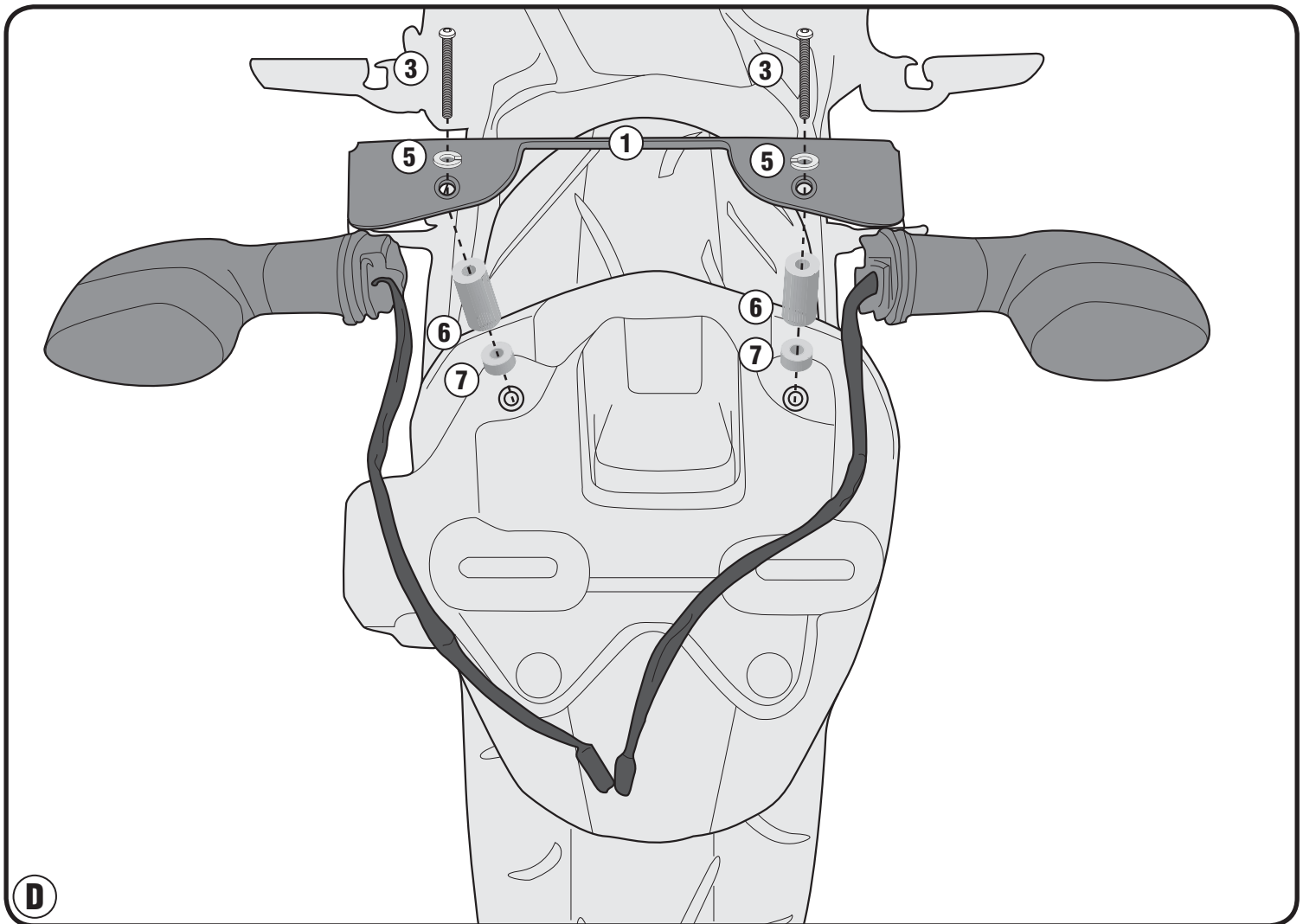
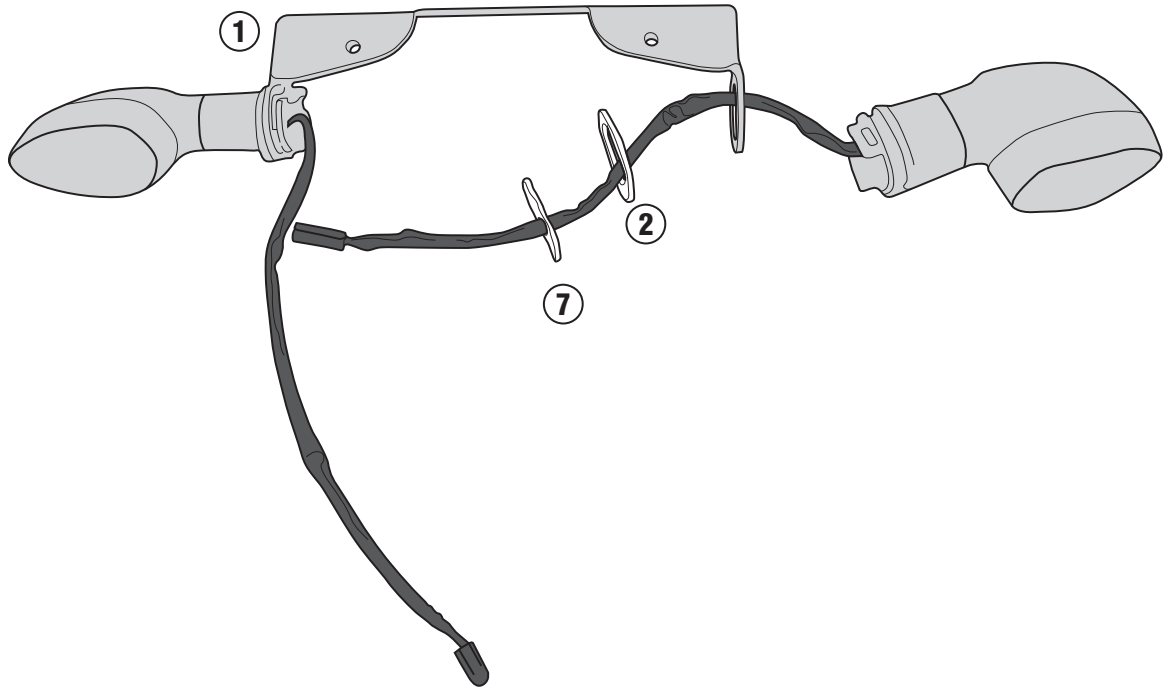

D