



Thank you for purchasing **A/F meter**, before operating the unit, please read these instructions thoroughly and retain them for future reference.

⚠ Notice

1. The LCD meter is made for **DC 12V**.
- P.S.** The oxygen sensor will start to detect the signal after starting the engine over one minute.
2. When installing the meter, please use the attached signal wire to avoid the electromagnetic wave interference caused by the wire.
3. For installation, please follow the steps described in manual. Any damage caused by wrong installation shall be imputed to the users.
4. To avoid a short circuit, please don't pull the wire when installing, don't break or modify the wire terminal.
5. Do not disassemble or change any parts in the manual description.
6. The interior examination or maintenance should be executed by our professionals.
7. **This unit is for Tuning purposes only.**

SYMBOL NOTE:

NOTE You could get the installation details from the information behind the mark.

⚠ Some processes must be followed to avoid the damage caused by wrong installation.

⚠ **WARNING!** Some processes must be followed to avoid damages to yourself or the public.

⚠ **CAUTION!** Some processes must be followed to avoid damage to the vehicle.



PRESS THE
BUTTON ONE TIME



PRESS THE
BUTTON 3
SECONDS

1-1 Accessories

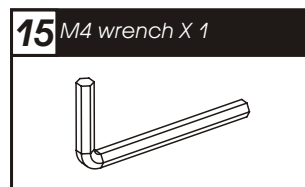
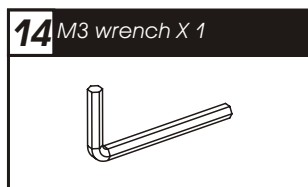
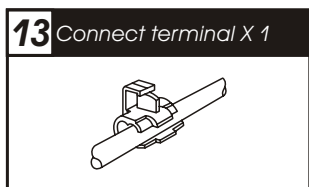
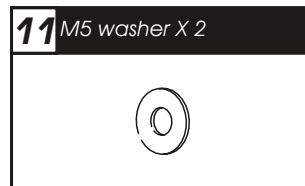
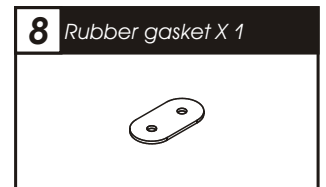
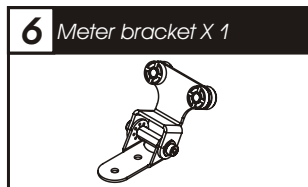
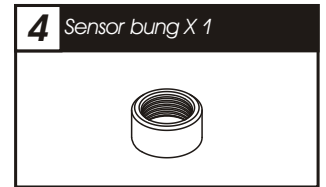
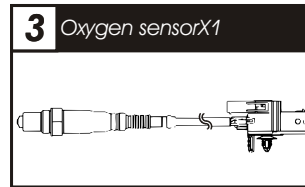
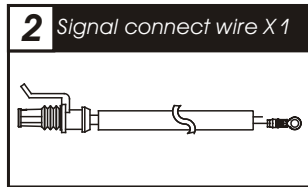
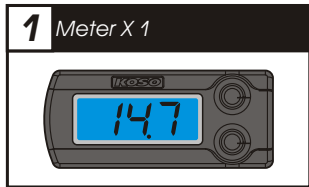

NOTE Please contact the local distributor if the items you open are not the same, with the above-listed one.

1-2 Option accessory

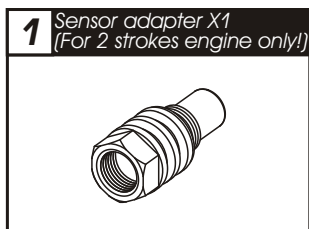

NOTE Some option accessories are not sold in some area. Please check with your dealer for more information.

2-1 Wiring installation instructions

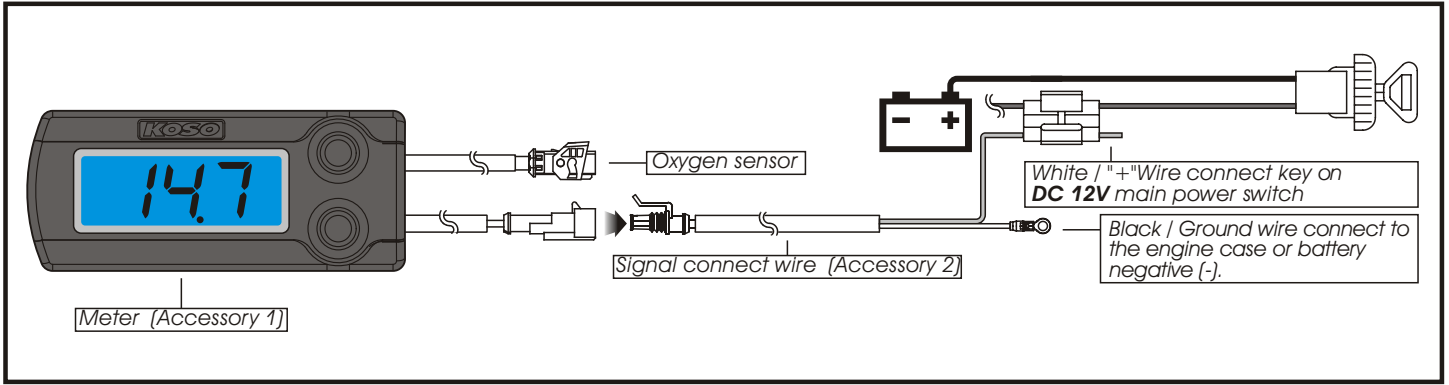

2-2 Oxygen sensor installation

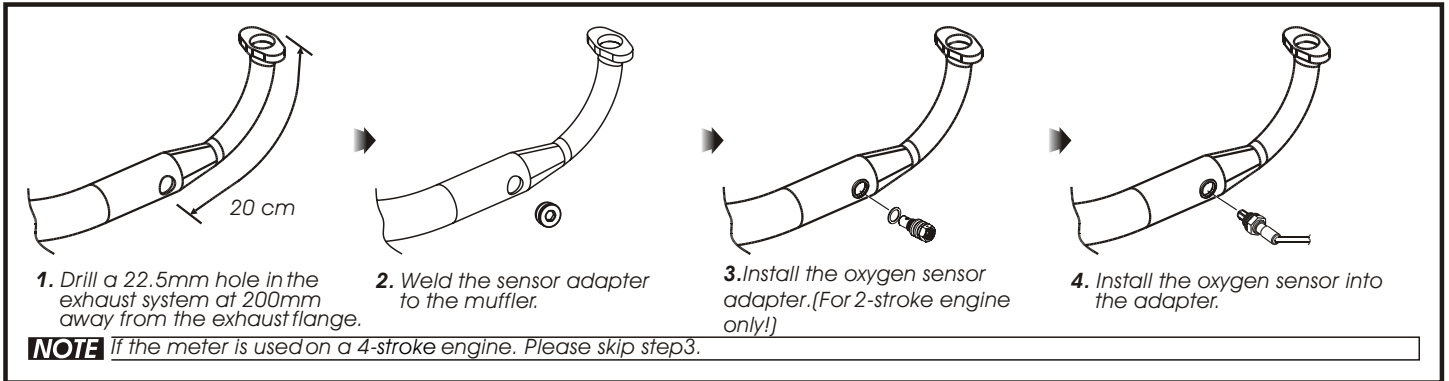

3-1 Instruction of function

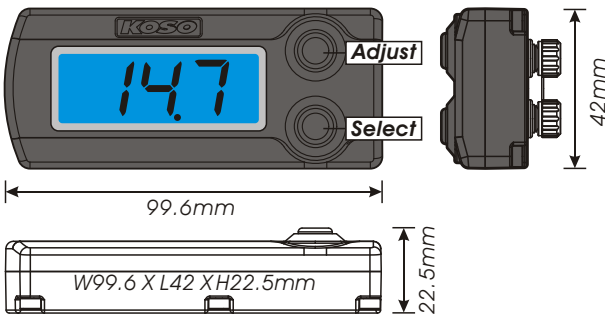

○ Display range	10.0~24.0
○ Over lean setting	LEAN 14.8~24.0
○ Over rich setting	RICH 14.6~10.0
○ A/F ratio display range	<0.5 second
● Back light	DC 12V
● Effective temperature range	-10~+60°C
● Water proof	JIS D 0203
● Meter size	W99.6 X L42 X H22.5mm
● Meter weight	+/- 85g

NOTE Design and specifications are subject to change without notice!

4-1 Function and setting

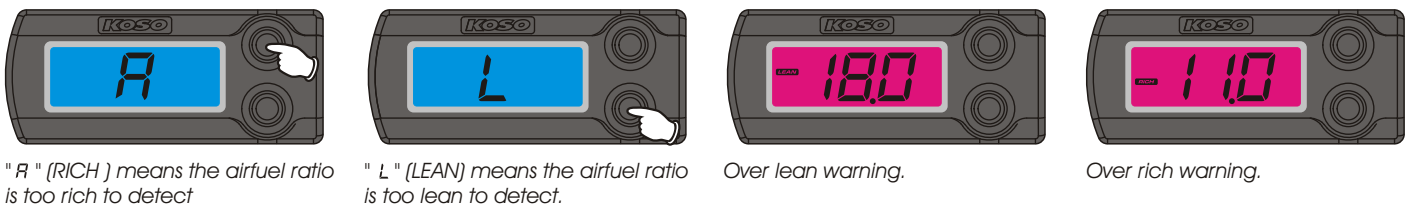

⚠ The backlight is lighting in blue now.

⚠ The backlight is lighting in blue now.

⚠ The **LEAN** symbol showing on screen, backlight is flashing by blue/red color now.

⚠ The **RICH** symbol showing on screen, backlight is flashing by blue/red color now.

5-1 The over lean warning setting.



On main screen, press down **SELECT & ADJUST** 3 seconds to enter the setting screen.



Press **ADJUST** button to enter the over lean setting screen. Press **ADJUST** button to turn on or turn off the function.

⚠ The  symbol is flashing now.

⚠ If you choose **OFF** the lean warning function will close. Press select button to enter into airfuel rich setting screen



Press **SELECT** to enter the over lean setting screen.

⚠ The  symbol is flashing now.



press **ADJUST** button to input the number you would like to set.

⚠ The digit can be set if flashing now.



press **SELECT** button to enter next digit.



Press **ADJUST** button to input the number you would like to set.

⚠ The digit can be set if flashing now.



press **SELECT** button to enter next digit.

⚠ The digit can be set if flashing now.



Press **ADJUST** button to input the number you would like to set.

⚠ The digit can be set if flashing now.



Press **SELECT** button to enter the over rich warning screen. For example : the lean warning setting was modified from 18.5 to 22.4 now.

⚠ The digit can be set if flashing now.



The over rich warning setting screen.

⚠ The  symbol is flashing now.

5-2 The over Ratio rich warning setting.



Press **ADJUST** button to enter the over lean setting screen. Press **ADJUST** button to turn on or turn off the function.

⚠ The  symbol is flashing now.

⚠ If you choose **OFF** the rich warning function will close. Press select button to return to main screen.



Press **SELECT** button to enter rich setting screen.

⚠ The digit can be set if flashing now.



Press **ADJUST** button to input the number you would like to set.

⚠ The digit can be set if flashing now.



Press **SELECT** button to enter next digit.

⚠ The digit can be set if flashing now.



Press **ADJUST** button to input the number you would like to set.

⚠ The digit can be set if flashing now.



Press **SELECT** once to return to main screen. Now the over rich warning setting is 13.8.

⚠ The digit can be set if flashing now.



Back to main screen.

6-1 Troubleshooting

CAUTION! Please install oxygen sensor as shown in installation 2.2, wrong installation will cause airfuel ration number display abnormal.



1. Oxygen sensor is not connected or the connection is bad.
2. oxygen sensor heater has failed.

Solution

1. Check the connection of the oxygen sensor if the warning message keeps showing. Please change to a new oxygen sensor.
2. press any button to restart the Oxygen sensor after check.

△ The back light showing blue the -- showing flash now.

NOTE Press any button to restart the oxygen sensor after check



1. Oxygen sensor has failed.
2. Battery voltage is too low

Solution

1. Check the connection of the oxygen sensor. If the warning message keeps showing. Please change to a new oxygen sensor
2. Check the battery voltage.

△ The back light is showing red now.

NOTE Press any button to restart the oxygen sensor after check



1. Oxygen sensor has failed.

Solution

1. Check the connection of oxygen sensor. If the warning message keeps showing. Please change to a new oxygen sensor.

△ The back light is showing red now.

NOTE Press any button to restart the oxygen sensor after check



1. Oxygen sensor has failed.

Solution

1. Check the connection of oxygen sensor. If the warning message keeps showing. Please change to a new oxygen sensor.

△ The back light is showing red now.

NOTE Press any button to restart the oxygen sensor after check

Warning

This Wide Band air/fuel gauge must be installed by a certified mechanic. Koso North America is not responsible for any damages that might be caused to the vehicle or its users.

- Do not cut or modify the sensor or wiring harness.
- Do not connect or disconnect the sensor when the instrument is working.
- Do not apply voltage above 18 volts DC.
- Do not open or modify the instrument or sensor.
- This instrument should be used as a tuning tool or race instrument.
- Connect the instrument only on DC power.
- Due to the nature of its use, the BOSCH LSU4.2 sensor is not covered by any warranty.
- Koso air/fuel ratio instrument is covered for any manufacturing defect for a period of 6 months following the date of purchase.

Facts about Air/fuel ratio

The first role of an oxygen sensor is to communicate to the ECU or the gauge if the engine is running lean or rich. The goal is to have the motor run at 14.7 parts of air for 1 part of fuel (Lambda 1). Having the engine running at 14.7 to 1 would represent the optimal exhaust combustion.

Oxygen sensor facts

The Koso Wide Band air/fuel ratio meter is currently using the BOSCH LSU4.2 sensor. The 5 wires Wide Band oxygen sensor is the most accurate sensor on the market. This sensor is able to read between 10.0 to 24.0 to 1. The operating temperature of the sensor should not exceed 1700 degree F. Using the sensor with leaded fuel or on 2 strokes engine will shorten the life of the sensor. Using a sensor bung adaptor will help extend the life of the sensor.

Calibration of the instrument

Each BOSCH LSU 4.2 oxygen sensor is individually laser trimmed with its own value for better results. The LSU 4.2 sensor is using a unique "breather" system located on the connector (figure 1) to calibrate himself. This means the sensor is self-calibrating with the ambient air so there is no need to calibrate the sensor. This process replaces the "free air" calibration procedure when changing the sensor or using the unit on another exhaust system was needed. It would be very important not to block the cap above the breather (figure 2) due to the fact that the sensor is self-calibrating by "breathing" air from this hole.

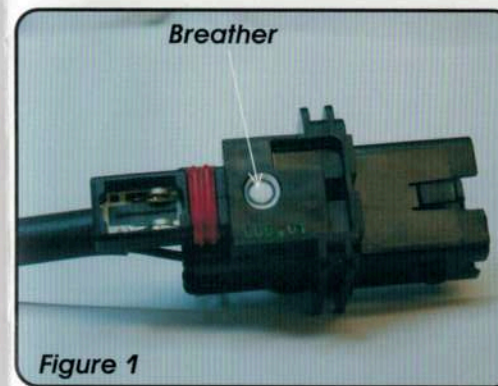

Figure 1

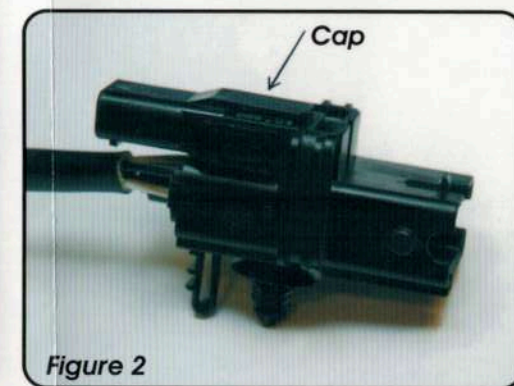

Figure 2

Oxygen sensor installation

According to the oxygen sensor manufacturer, for better results, the sensor should be installed at the warmest location on the exhaust system. This would usually represent the first part of the exhaust which would be 6 to 12 inches from the piston skirt (figure 3). On a 2 strokes engine, it is strongly recommended to use a sensor bung adaptor to lower the impact of oil contamination (figure 4) on the O2 sensor. The sensor should be assembled with high temperature non permanent grease and tightened at 40-60 Nm. The use of cleaning fluids at the sensor plug is not permitted. Avoid any water or condensation on the tip of the sensor otherwise it might damage the internal components. Sensor must be installed with an angle of at least 10 degree (figure 5). Thus preventing the collection of liquids between sensor housing and sensor element during the cold start phase.



Figure 4

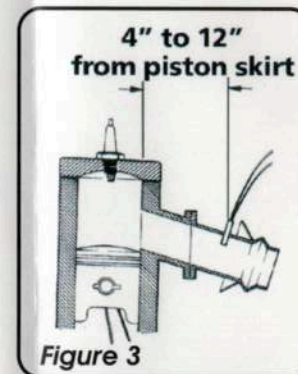

Figure 3

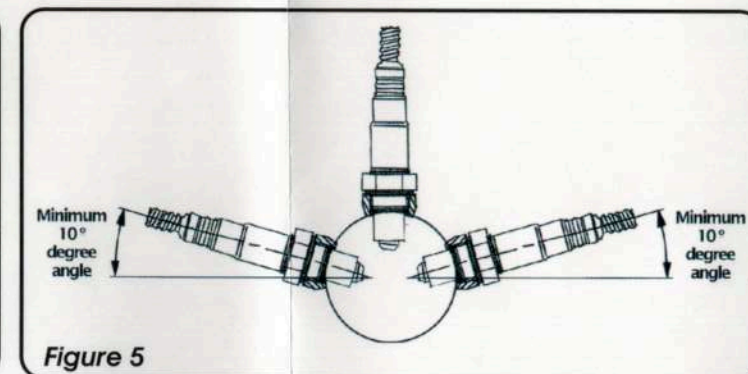

Figure 5