



● Thank you for purchasing KOSO style speedometer. Before operating the unit, please read the instruction thoroughly and retain it for the future reference.

NOTICE

1. The lcd meter is apply for **DC 12V**.
2. For installation, please follow the steps described in manual. Any damage caused by wrong installation shall be imputed to the users.
3. To avoid the short circuit, please don't pull the wire when installing. Don't break or modify the wire terminal.
4. Do not disassemble or change any parts excluding the manual description.
5. The interior examination or maintenance should be executed by our professionals.

MARK MEANING:

NOTE You could get the installation details from the information behind the mark.

△ Some processes must be followed to avoid the affection caused by wrong installation.

WARNING! Some processes must be followed to avoid damages to yourself or the public.

CAUTION! Some processes must be followed to avoid the damage to the vehicle.



Flash



Press the button one time



Press down the button for 3 seconds.

1-1 ACCESSORY

<p>1 Meter X1</p>	<p>2 Passive speed sensor X1</p>	<p>3 D6 x 5L mm magnet x 6</p>	<p>4 RPM wire set (Type A) X1</p>
<p>5 RPM wire set (Type B) X1</p>	<p>6 Mid-way connect X 11</p>	<p>7 M8/ S type speed sensor bracket x 1</p>	<p>8 M10/ S type speed sensor bracket x 1</p>
<p>9 M5 x 5L mm Hexagon screw x 2</p>	<p>10 2.5 mm allen key x 1</p>	<p>11 V type Meter bracket x 1 set</p>	<p>12 Handle bar clamp x 1</p>
<p>13 Rubber x 1</p>	<p>14 M6 x 18L mm screw x 1</p>	<p>15 M5 x P0.8 mm nut x 2</p>	<p>16 M6 x P1.0 mm nut x 1</p>
<p>17 M5 washer x 2</p>	<p>18 M6 washer x 1</p>	<p>19 Aluminum bushing x 1</p>	

NOTE Please contact the local distributor if the items you open are not the same, with the above-listed one.

1-2 OPTION ACCESSORY

<p>1 Bolt Magnet</p> <p>5/16-18 X 22.1L M5 X P0.8 X 12L M6 X P1.0 X 12.6L M6 X P1.0 X 19.7L M6 X P1.0 X 24L M8 X P1.25 X 22.5L M8 X P1.25 X 27.5L M8 X P1.25 X 29L M10 X P1.25 X 28.3L</p>	<p>2 Active speed sensor</p>	<p>3 L type speed sensor bracket</p>
---	-------------------------------------	---

NOTE The optional active speed sensor can read up to 20 pulsations and not require the installation of any magnets to pick up the speed. Note that the passive speed sensor supplied with this instrument can read up to 6 pulsations.

NOTE Some of the optional accessories listed might not be sold in your country. Contact your local distributor to get more details.

2-1 WIRING INSTALLATION INSTRUCTIONS

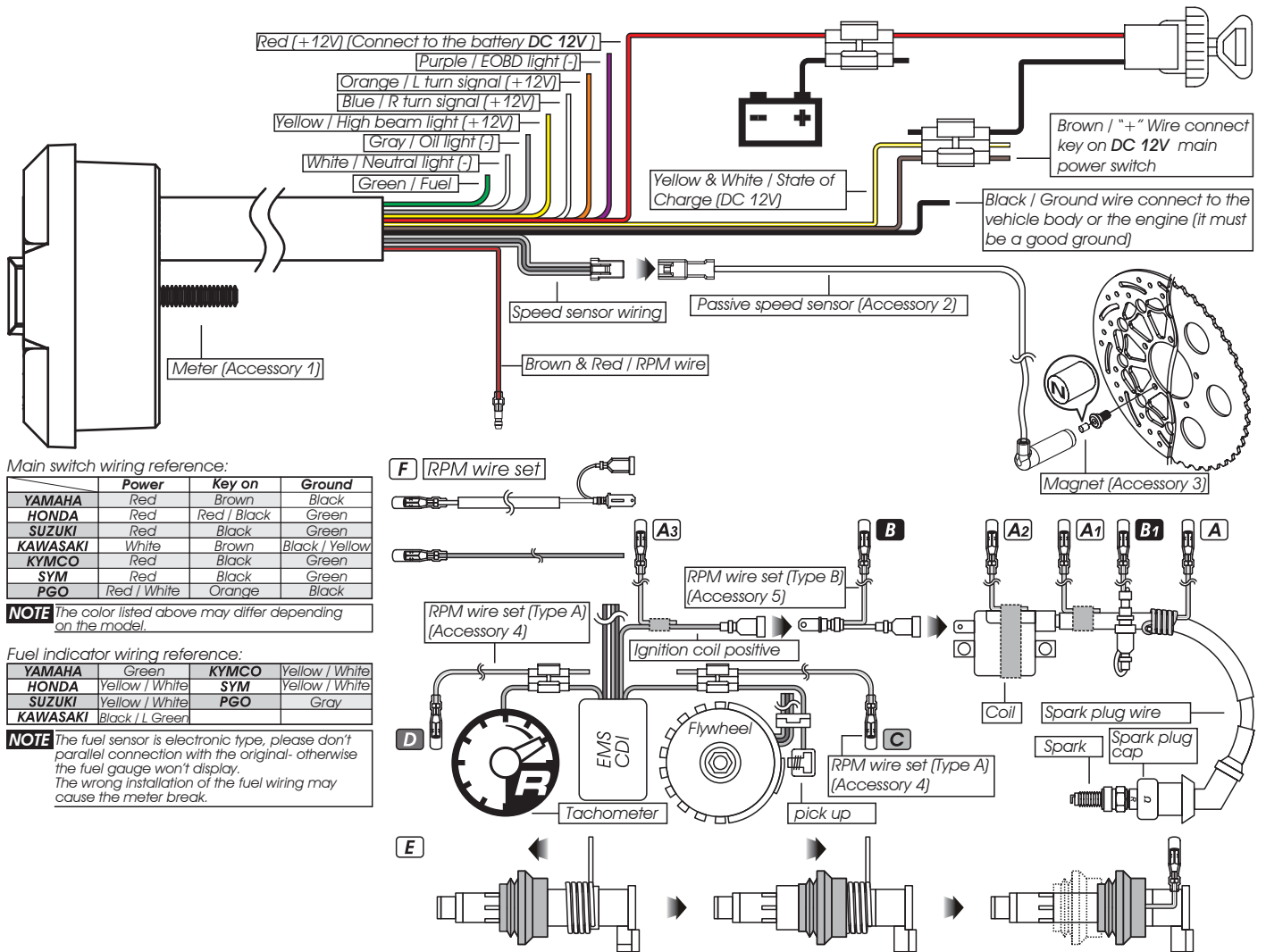

NOTE The temperature will disappear if you don't install & connect the temperature sensor with the meter.

NOTE When connecting the power wiring, please follow the instruction. If you connect the red & brown wiring in parallel will cause the meter work improperly.

⚠ The RPM wire installation

A. Please wrap the RPM wire at least 5 times around the spark plug.

A1. Please use tape to fix the RPM (Type A) wire onto the spark plug wire.

A2. Please use tape to fix the RPM wire (Type A) on the spark plug cap.

A3. Please use tape to fix the RPM wire (Type A) on the coil positive pole wire. For some models with the coil negative wire, please tape the RPM wire (Type A) on the negative wire to get the RPM signal. (For example, the YAMAHA V-max 1200)

B. Please connect the RPM wire (type B) to connect to the ignition coil positive pole.

B1. Please wrap the RPM wire (type B) on the spark plug wire by connecting the male and female connector.

C. Please connect the RPM wire (Type A) to the pick up.

D. Please parallel the RPM wire (Type A) with the original tachometer signal wire (This method is available only when the original speedometer comes with a tachometer on it. You could get the RPM wire information from the service manual of your bikes.)

E. For the models comes with the new ignition coil, please wrap the RPM wire (Type A) at least 5 times around the spark plug as the above drawing.

F. Please use the method mentioned above to install the RPM wire, and then connect the ground wire to the frame body or the engine. (Please make sure that the ground is a good ground.)

For multi-ignition models, we will suggest you to get the signal on the first ignition.

The best signal source will be in order as D>C>B>A, we will suggest you to check different ways if you have problems to get the RPM signal.

2-2 INSTALLATION INSTRUCTION

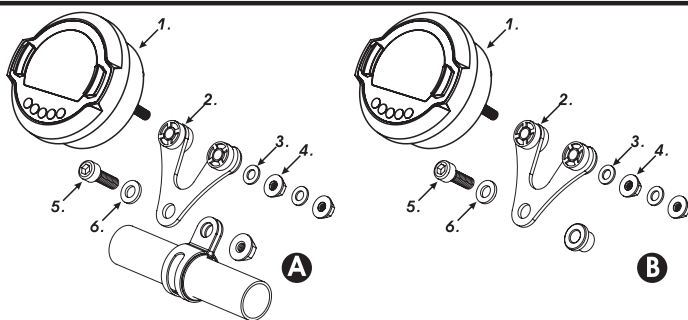

FOLLOW THOSE STEPS WHEN INSTALLING

1. LCD meter (Accessory 1)
2. Meter bracket (Accessory 11)
3. M5 washer x 2 (Accessory 17)
4. M5 x P0.8 nut x 2 (Accessory 15)
5. M6 x 18L screw (Accessory 14)
6. M6 washer (Accessory 18)

A Use the meter bracket (Accessory 11), handle bar clamp (Accessory 12), rubber (Accessory 13) and M6 x P1.0 nut (Accessory 16) to install the speedometer on the handle bar.

B Use the aluminum bushings (Accessory 11) to install the speedometer on the handle bar stem.

2-3 INSTALLATION INSTRUCTION

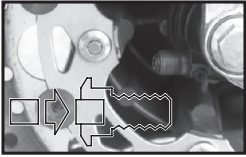

Put the magnet into the brake disc screw hole.

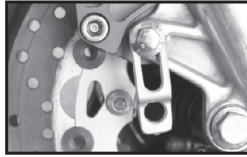

Install the S type sensor bracket.

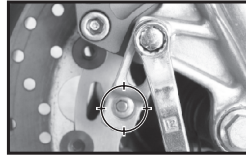

Adjust the sensor bracket position to make sure the sensor is facing the magnet to prevent bad speed signal.

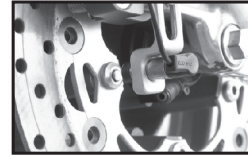

Install the speed sensor on the bracket.

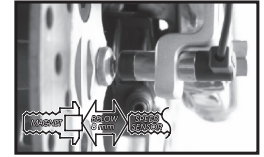

In order to get a good speed signal, the distance between the speed sensor and magnet should be under 8mm.

P.S.



Higher number of magnets installed on the disk brake will result in a faster speed display on the gauge. The letter "N" on the magnets must face the speed sensor in order to pick up correctly the speed.

EX 1: If the disk brake has 3 screws, you can install 1 or 3 magnets.

EX 2: If the disk brake has 4 screws, you can install 1, 2 or 3 magnets.

EX 3: If the disk brake has 5 screws, you can install 1 or 5 magnets.

EX 4: If the disk brake has 6 screws, you can install 1, 2, 3 or 6 magnets.

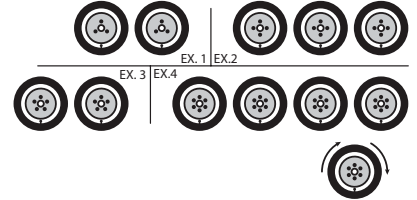

3-1 OVERVIEW

Fuel Level

- Display range: 4 levels
- The fuel level begins to flash when only 1 level left.
- If you don't install the fuel wiring, the fuel will not display.

Odometer

- Display range: 0~99999.9 km(mile), reset automatically after 99999.9 km(mile).
- Display unit: 0.1 km(mile).

Trip meter A, B

- Display range: 0~999.9 km (mile), reset automatically after 999.9 km(mile).
- Display unit: 0.1 km(mile).

Fuel / Remaining Distance

- Display range: 999.9~0 km (mile).

Indicators lights

- Turn signal light (Green)
- Neutral light (Green)
- High beam light (Blue)
- Engine oil pressure light (Red)
- EOBD light (Amber)

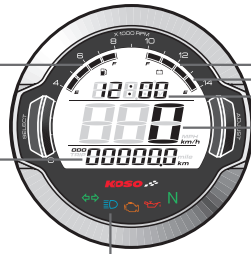

Clock

- 24 H.

Digital Volt meter

- Display range: DC 5~24 V.

Speedometer

- Display range: 0~360 km/h. (0~225 MPH)
- Display unit: 1 km/h (MPH)

Volt meter

- Display range: 4 levels.
- The voltage level begins to flash when only 1 level left.

Tachometer

- Display range: 15 levels.
- Each level represents 1000 RPM.

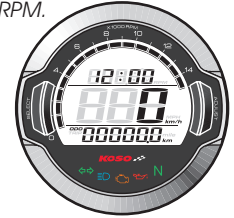

3-2 FUNCTION, SETTING INSTRUCTION

● Speedometer	Display range: 0~360 km/h (0~225 MPH) Display unit: 1 km/h (MPH)	● Digital Volt meter	Display range: DC 5~24 V, Flashing Warning when Voltage lower than 8V or higher than 18V.
○ Display interval	<0.5 second	● Volt meter	Display range: 4 levels Display unit: 1 level (Low) - DC 11.6~12.0 V 2 level - DC 12.1~12.5 V 3 level - DC 12.6~13.0 V 4 level (High) - DC 13.1 V~
○ Odometer	Display range: 0~99999.9 km (mile), reset automatically after 99999.9 km (mile); Display unit: 0.1 km (mile)	○ Insufficient volt warning	Voltage level begins to flash when only 1 level left
○ Trip meter A, B	Display range: 0~999.9 km (mile), reset automatically after 999.9 km (mile); Display unit: 0.1 km (mile)	● Backlight brightness adjust	Setting range: 1-5(Darkest)~5-5(Brightest) Setting unit: adding 20 % each adjustment (5 segments)
○ Fuel / Remaining Distance	Display range: 999.9~0 km (mile) Display unit: 0.1 km (mile)	● Effective voltage	DC 12V
○ Tire circumference	Setting range: 300~2500 mm Setting unit: 1 mm . Sensor point: 1~20	● Effective temperature range	-10~+60°C
● Tachometer	Display range: 15 levels (Each level represents 1000 RPM)	● Meter standard	JIS D 0203 S2
● Fuel Level	Display range: 4 levels The fuel symbol begins to flash if only 1 level is left.	● Meter size	135.7 X 100.7 X 52 mm
○ Fuel resistance	Setting range: 100Ω、250Ω、510Ω、1200Ω	● Meter weight	Around 240g
● Clock	24 H	● Indicator light color	High beam-blue, Turn signal-green Oil-red, Neutral-green, EOBD light-Amber

NOTE Design and specification are subject to change without notice!

3-3 BUTTON FUNCTION INSTRUCTION

Press the Select button

In main screen: Press the **Select button** to switch between clock, volt.

In setting screen: Press the **Select button** to change the setting cursor.

When the meter is off, press the **Select button** to wake up the clock.

Hold pressing the Select button for 3 seconds.

In main screen: Hold pressing the **Select button** for 3 seconds to switch between fuel, volt, RPM.

In setting screen: Hold pressing the **Select button** for 3 seconds to return the main screen

Press the Adjust button

In main screen: Press the **Adjust button** to switch between Odometer, Trip A, Trip B, Fuel / Remaining distance.

In setting screen: Press the **Adjust button** to change the setting value.

When the meter is off, press the **Adjust button** to wake up the clock.

Hold pressing the Adjust button for 3 seconds

In record screen such as Trip A, Trip B, hold pressing the **Adjust button** for 3 seconds to reset the record, and switching the unit for Mileage and Speed.

Hold pressing the Adjust button for 10 seconds

In Fuel / Remaining distance screen: Reset the Remaining Mileage to 0 and restart the learning.

Hold pressing the Adjust button

In setting screen: You could switch the setting value faster by holding pressing the **Adjust button**.

Hold pressing the Adjust+Select for 3 seconds

In main screen, Hold pressing the **Adjust+Select** for 3 seconds to enter the setting screen.

3-4 STAND BY FUNCTION INSTRUCTION



- When the meter is off, press **Adjust or Select button** to wake up clock function.



- The clock will display 30 seconds after wake up.

3-5 MAIN FUNCTION SWITCH INSTRUCTION (ADJUST BUTTON)

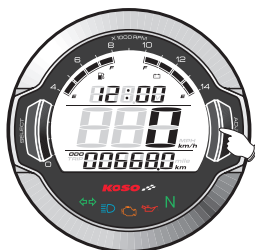

- In main screen (ODO). Press the **Adjust button** one time to enter the Trip A screen.
- Hold pressing the **Adjust button for 3 seconds** to switch between the digital speedometer and the digital Odometer.

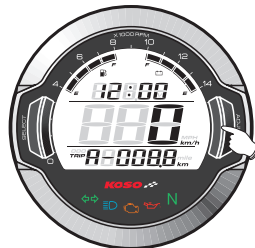

- In Trip A screen. Press the **Adjust button** one time to enter the trip B screen.
- Hold pressing **Adjust button for 3 seconds** to reset Trip A record.

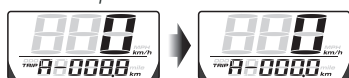

- In Trip B screen. Press the **Adjust button** one time to enter the Fuel / Remaining distance screen.
- NOTE** If you don't install the fuel wiring, the fuel / remaining distance will not display, can change to the odo screen.
- Hold pressing **Adjust button for 3 seconds** to reset Trip B record.



- In the fuel / remaining distance screen, press the **Adjust button** one time to go back to the main screen (ODO).

Remaining Mileage Learning Procedure:

- Fill the tank to full and in the remaining mileage screen press **Adjust button** for 10 seconds, then the ODO symbol will flashing and remaining mileage will reset to 0 and restart the learning.

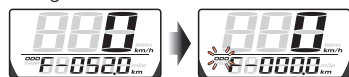

- When the fuel level of the bike reach to 0, please refill the tank to full. When this process has been done, the ODO symbol will stop flashing which means the Remaining Mileage Learning has completed.

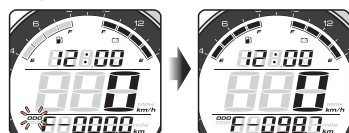

WARNING! Remaining Mileage might have difference between actual mileage and calculated mileage according to the road condition, vehicle condition, riding method and so on. Thus the Remaining Mileage is only a suggesting reference to the rider

3-8 SETTING SCREEN INSTRUCTION

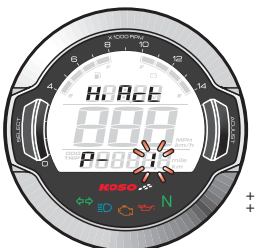

- In setting screen, you could press the **Select button** to enter the setting. The setting screen is in order as below: input pulse setting, the tire circumference setting, the fuel resistance setting, clock, backlight brightness, internal odometer display, external odometer setting.

⚠ If you don't take any action in 30 seconds, the screen will return to the main screen automatically.

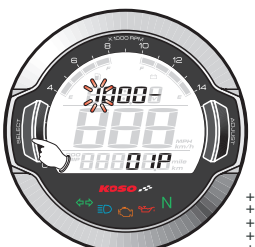

+3
+4
+5
+6
+7
+8

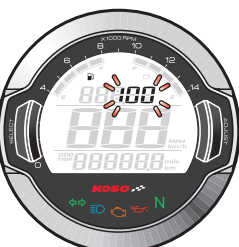

+9



+10
+11
+12

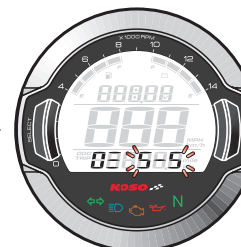

+13

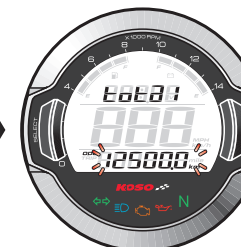

+14

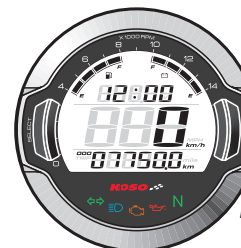

main screen

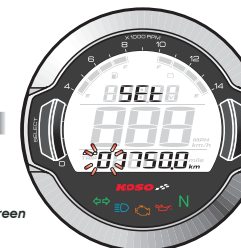

+15
+16
+17
+18
+19
+20

3-6 MAIN FUNCTION SWITCH INSTRUCTION (SELECT BUTTON)

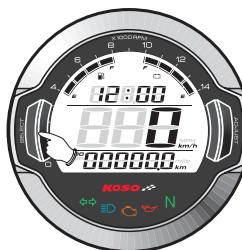

- In the clock screen, press the **Select Button** one time to switch to the volt screen.

NOTE If you don't install the volt wiring, the volt will not display

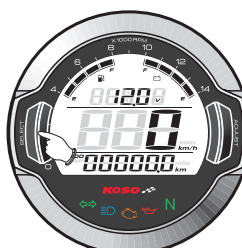

- In the volt screen, press the **Select Button** one time to switch to the clock screen.

3-7 RPM FUNCTION INSTRUCTION



- In the fuel, volt screen, hold pressing the **Select Button for 3 seconds** to switch to the RPM screen.



- In the RPM screen, hold pressing the **Select Button for 3 seconds** to switch to the fuel, volt screen.

In the RPM screen

- When Fuel Level remain 1 level, the Fuel symbol will flashing as warning.



- When Battery Level remain 1 level, the Battery symbol will flashing as warning.



4 Entering ENTERING SETTING SCREEN

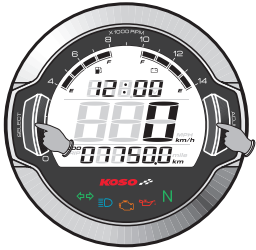

- In main screen, Hold pressing the **Select & Adjust button** for 3 seconds to enter the setting screen.

4-1 The RPM input signal setting

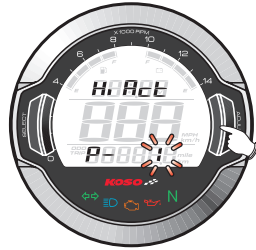

- EX. You want to connect the RPM signal wire to the pick up signal and there are 13 flywheel signals per turn.
- Press the **Adjust button** to change the setting.
- EX. Now the current input signal setting is 1.
- ⚠ Now the digit under setting is flashing!

NOTE Setting range: 0.5, 1 ~24.

Setting value	2 strokes setting	4 strokes setting	RPM per spark
0.5		1 piston	2 RPM signals per 1 spark.
1	1 piston	2 pistons	1 RPM signal per 1 spark.
2	2 pistons	4 pistons	1 RPM signal per 2 sparks.
3	3 pistons	6 pistons	1 RPM signal per 3 sparks.
4	4 pistons	8 pistons	1 RPM signal per 4 sparks.
5		10 pistons	2 RPM signals per 10 sparks.
6	6 pistons	12 pistons	1 RPM signal per 6 sparks.

NOTE For most of Injection Model, setting value might exceed 6 if RPM connection method B is chosen, and it depend on the number of the bump it has on its flywheel.

CAUTION! Most of the 4-cycle bikes with one single piston are igniting every 360 degree once, so the setting should be the same as the bike with 2-cycle and one piston engine.

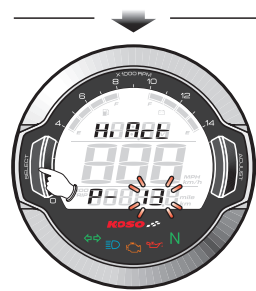

- Press the **Select button** one time to enter the input pulse setting.
- EX. Now the RPM input signal number setting is changed from 1 to 13.



- EX. We want to change the setting to Hi. (The negative signal pulse.)
- Press the **Adjust button** to choose waveforms you would like to set.
- EX. Now the current setting is Hi.
- ⚠ Now the pulse setting is flashing!

NOTE We define the RPM input pulse as Hi (The positive pulse) & Lo (The negative pulse.)

NOTE If the RPM displayed on the meter is incorrect or with noise, please choose another setting and try it again.

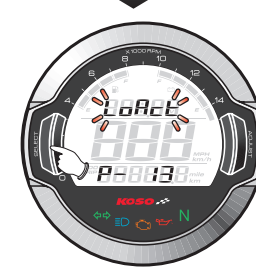

- After the setting, keep pressing the **Select button** one time to enter the tire circumference compensation setting.
- EX. Now the input pulse setting changed from is Hi to Lo.

4-2 THE TIRE CIRCUMFERENCE COMPENSATION SETTING



⚠ Please reset this setting value when you change a different size tire.

- EX. The new tire circumference is 130 cm. The calculation equation is as below.
- The new tire circumference (130 cm) ÷ the original tire circumference (125 cm) X 100 % = The setting value (104 %).
- Please keep pressing the **Select button** and release it until it move to the setting digital you want.
- EX. The original setting is 1000.
- ⚠ Now the setting digital value is flashing!

NOTE Setting range: 300~2500.
Setting unit: per 1 %.

P.S.



- You could define the valve as the starting point and the terminal point to measure the wheel circumference with a measuring tape.

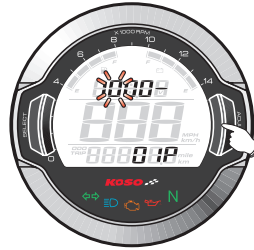
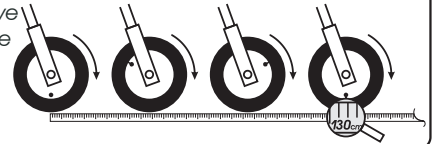

- Then press the **Adjust button** to change the setting value.



- After the setting, keep pressing the **Select button** one time to enter the sensor point setting.

- EX. The tire circumference adjust setting is changed from 1000 mm to 1300 mm.

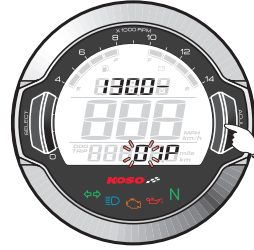

- EX. The sensor point you want to set is 06P.
- Press the **Adjust button** to change the setting.
- EX. New the sensor point setting is 01P.
- ⚠ Now the sensor point setting is flashing!

NOTE Setting range: 1~20 point.

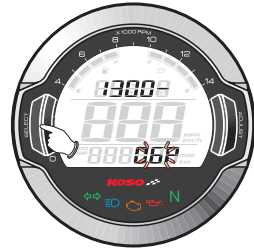

- After the setting, keep pressing the **Select button** one time to enter the fuel resistance setting.

- EX. The sensor point setting is changed from 01P~06P.

4-3 THE FUEL RESISTANCE SETTING



- EX. The fuel gauge need to be set to 510Ω.
- Press the **Adjust button** to choose the setting number.



NOTE The fuel gauge resistance setting range: 100Ω、250Ω、510Ω、1200Ω
If you don't install the fuel wiring, the fuel gauge will not display.

NOTE When Fuel Resistance Setting is changed, the remaining Mileage will be reset to 0 and have to restart the learning process. About the Learning process please refer to the instruction from 3-5.

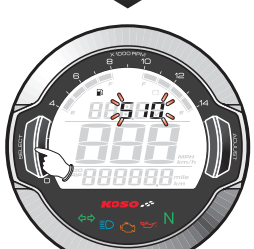

- After the setting, keep pressing the **Select button** one time to enter the clock setting.
- EX. The fuel resistance setting is changed from 100 to 510.

4-4 THE CLOCK SETTING

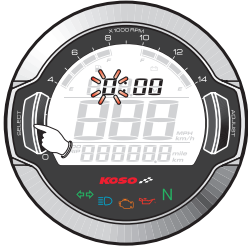

- EX. We would like to set the clock at 0:05.
- Please keep pressing the **Select button** and release it until it move to the setting digital you want.
- EX. Now the current clock setting is 0:00.
- ▲ Now the setting digital value is flashing.
- NOTE** This is a 24H clock. The setting is in order from hour to minutes.

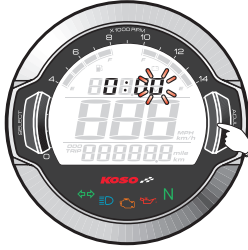

- Then press the **Adjust button** to change the setting value.

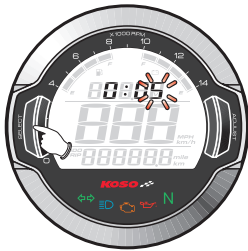

- After the setting, keep pressing the **Select button** one time to enter the backlight brightness setting.
- EX. Now the clock is setting from 0:00 to 0:05.



4-5 THE BACKLIGHT BRIGHTNESS SETTING

- EX. We would like to change the brightness to 3-5 (60 % brightness.)
- Please keep pressing the **Adjust button** and release it until it move to the setting digital you want.
- EX. The current backlight brightness setting is 5-5.
- NOTE** The setting range: 1-5 (Darkest) ~5-5 (Brightest), 5 different levels for choosing. Setting unit : 20 % per level. The backlight brightness will change immediately after you adjust the setting value.

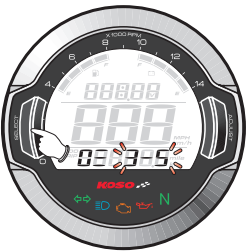

- After the setting, keep pressing the **Select button** one time to enter the internal odometer display setting.
- EX. The backlight brightness setting is changed from 5-5 to 3-5.

4-6 INTERNAL ODOMETER DISPLAY

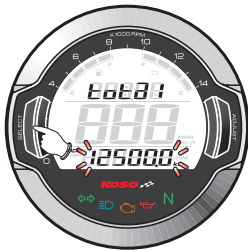

- After the setting, keep pressing the **Select button** one time to enter the external odometer setting.
- EX. The internal odometer display is 12500.0 km.

4-7 EXTERNAL ODOMETER SETTING



- EX. We would like to set the external odometer to 15000.0 km.
- Please keep pressing the **Select button** and release it until it move to the setting digital you want.
- EX. The external odometer setting is 7750.0 km.



- Then press the **Adjust button** to change the setting value.



- After the setting, keep pressing the **Select button** one time to back to the main screen
- EX. The external odometer setting is changed from 7750.0 to 15000.0 km.



- The main screen.

6 THE CLOCK SETTING

The following situation do not indicate malfunction of the meter. Please check the following before taking it in for repair.

Trouble	Check item
The meter doesn't work when the power is on.	<ul style="list-style-type: none"> ●The power doesn't supply to the meter. <ul style="list-style-type: none"> →Please make sure the wiring is connected. The wiring and fuse are not broken. →The battery is broken or the battery is too old to supply enough power (DC 12V) to make the meter work.
The meter shows wrong information.	<ul style="list-style-type: none"> ●Please check the voltage of your battery, and make sure the voltage is over DC 12V. ●Please make sure the cable is connected correctly. ●Check the tire-size setting, refer to the manual 4-2.
Speed does not appear or appear incorrectly.	<ul style="list-style-type: none"> ●Please check your fuel tank <ul style="list-style-type: none"> →is there any fuel inside? ●Please check the wiring <ul style="list-style-type: none"> →Did you connect the wiring correctly? ●Please check the setting <ul style="list-style-type: none"> →Refer to the manual 4-3.
Fuel gauge dose not appear or appear incorrectly.	<ul style="list-style-type: none"> ●It is possible that the permanent power wire is not connected well. <ul style="list-style-type: none"> →Please check the red positive wire is connect well or not.
The odometer and trip meter is not accumulated or accumulated wrong data.	

※If still can't solve the problems according to the steps above, please contact with distributors or us.