

# !!! WARNING !!!

This is an aftermarket part built for racing purposes only.

Koso is not responsible for any damages caused to the parts, vehicle, or to yourself and others.

Engine parts are not under warranty nor is collateral damage or cost of labor, in cases of malfunction.



• Thank you for purchasing HONDA MSX HURRICANE MULTI AIR FILTER, please read the instruction thoroughly before installing.

**⚠ Notice**

- For installation, please follow the steps described in manual. Any damage caused by wrong installation shall be imputed to the users.
- Don't break or modify the wire terminal. To avoid the short circuit, please don't pull the wire when installing.
- Do not disassemble or change any parts excluding the manual description.
- The interior examination or maintenance should be executed by our professionals.

◎ MARK MEANING:

**NOTE** You could get the installation details from the information behind the mark.

**⚠** Some processes must be followed to avoid the affection caused by wrong installation.

**⚠ WARNING!** Some processes must be followed to avoid damages to yourself or the public.

**⚠ CAUTION!** Some processes must be followed to avoid the damage to the vehicle.

**1-1 Accessory**

**1** Individual upper and lower cover of filter X1



**2** High-density sponge X1



**3** Low-density sponge X1



**4** M5x35 Screw X8



**5** M3.5 Screw X5



**NOTE 1** 1. The camshaft component was already installed on the body when purchased.

2. Please contact the local distributor if the items you open are not the same, with the above-listed one.

**1-2 Optional Accessories**

**1** Cylinder (61mm)

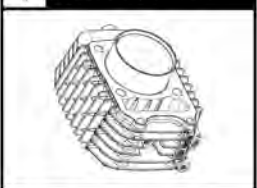

**2** Throttle body (34mm)



**3** Intake manifold (30.5mm)



**4** Connecting Tube



**5** Sub Tube



**NOTE** Some of these items may not sell in particular area, for more information, please contact with our local dealer.

**2 You may opt to install the outer cover**

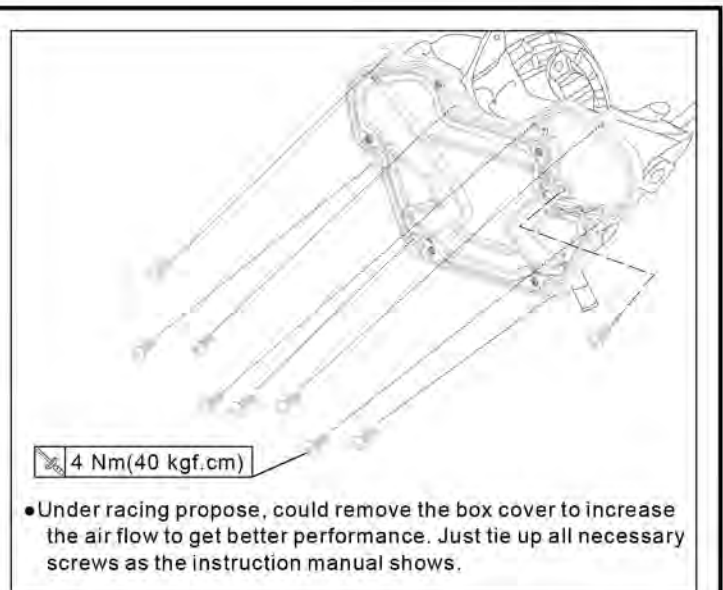
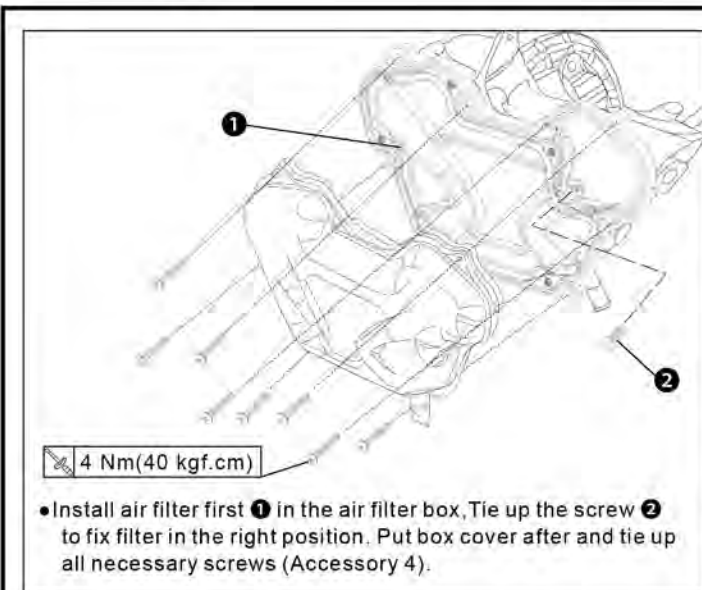

**⚠ CAUTION!** If bike falls down or have found mass fuel leaking, make sure you clean up the fuel sucked by sponge (Warning: leaking fuel may caused fire during engine start).

### 3 Replace filter cartridge

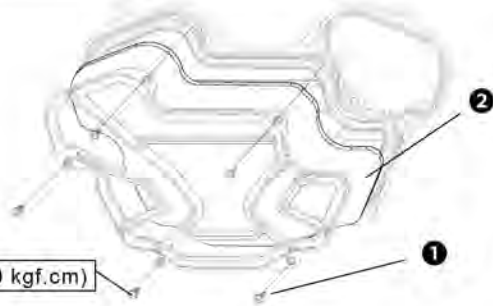

- To replace filter cartridge, remove **1** screws (Accessory 5) and **2** replace sponge (two sponges with different densities are available). After replace sponge, make sure you tie up all necessary screws (Accessory 5).

**CAUTION!** To avoid air leaking or unseal appropriately, make sure install sponge in correct place.

### 4 Curve Test Diagram

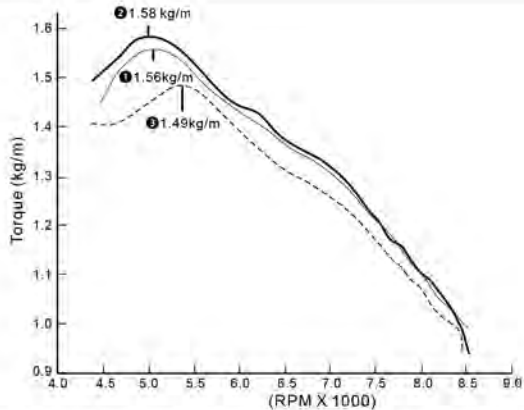
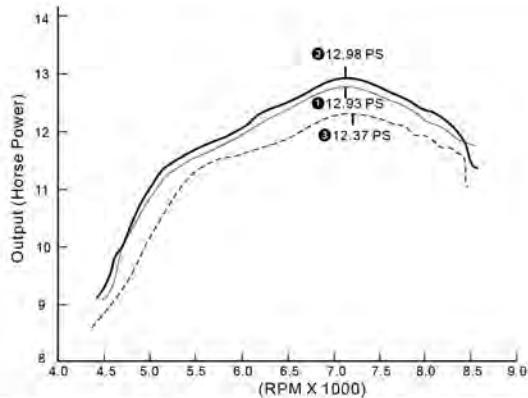

**NOTE 1** ENDURANCE Cylinder (61mm)+ENDURANCE Camshaft (240°)+ENDURANCE Hurricane multi air filter (High-density sponge x1)+other parts are Honda stander parts. (Test with 3RD gear positon)

**NOTE 2** ENDURANCE Cylinder (61mm)+ENDURANCE Camshaft (240°)+ENDURANCE Hurricane multi air filter (Low-density sponge x1)+other parts are Honda stander parts. (Test with 3RD gear positon)

**NOTE 3** ENDURANCE Cylinder (61mm)+ENDURANCE Camshaft (240°)+other parts are Honda stander parts. (Test with 3RD gear positon)

**NOTE** Test results vary with testing environment and weather. This test chart is for reference only.

### 5 Acceleration speed test diagram

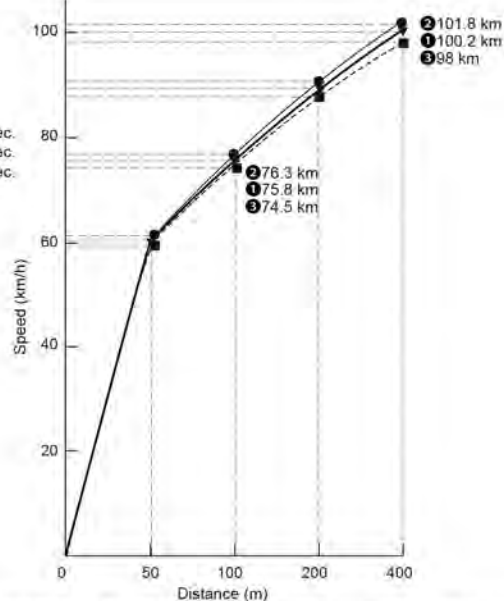
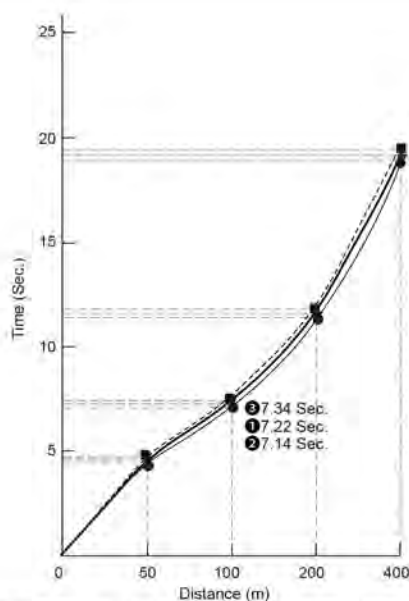

**NOTE 1** ENDURANCE Cylinder (61mm)+ENDURANCE Camshaft (240°)+ENDURANCE Hurricane multi air filter (High-density sponge x1)+other parts are Honda stander parts.

**NOTE 2** ENDURANCE Cylinder (61mm)+ENDURANCE Camshaft (240°)+ENDURANCE Hurricane multi air filter (Low-density sponge x1)+other parts are Honda stander parts.

**NOTE 3** ENDURANCE Cylinder (61mm)+ENDURANCE Camshaft (240°)+other parts are Honda stander parts.

**NOTE** Test results vary with testing environment and weather. This test chart is for reference only.