

INSTALLATION INSTRUCTIONS

HYPERCHARGER™ ES FOR SPORTSTER, CHROME & BLACK

9352

THANK YOU FOR CHOOSING KURYAKYN!

Protect yourself and others from possible injury and property damage or loss. Pay close attention to all instructions, warnings, cautions, and notices regarding the installation, use, and care of this product.

WARNING THIS INDICATION ALERTS YOU TO THE FACT THAT IGNORING THE CONTENTS DESCRIBED HEREIN CAN RESULT IN POTENTIAL DEATH OR SERIOUS INJURY.

CAUTION THIS INDICATION ALERTS YOU TO THE FACT THAT IGNORING THE CONTENTS DESCRIBED HEREIN CAN RESULT IN MINOR OR MODERATE POTENTIAL INJURY.

NOTICE THIS INDICATION ALERTS YOU TO THE FACT THAT IGNORING THE CONTENTS DESCRIBED HEREIN MAY NEGATIVELY AFFECT PRODUCT PERFORMANCE AND FUNCTIONALITY OR DAMAGE THE PRODUCT ITSELF OR THE PRODUCT TO WHICH IT IS BEING ATTACHED.

ENSURE THAT THE FOLLOWING PARTS HAVE BEEN INCLUDED IN THE KIT:

- | | | | |
|---|---|---|------------------------------------|
| 1 | Hypercharger ES Assembly | 1 | Breather Manifold Kit, containing: |
| 1 | Controller | 1 | Breather Manifold |
| 1 | Hardware Kit, containing: | 2 | Breather Bolts |
| 3 | 1/4-20 x 1" Flat Head Socket Cap Screws | 6 | Rubber Coated Washers |
| 4 | 6" Cable Ties | 2 | O-Rings |
| | | 1 | Front Gasket |
| | | 1 | Back Gasket |

YOU WILL ALSO NEED:

Set of hex wrenches, set of hex bit sockets, in-lbs (Nm) and ft-lb torque wrench, Blue Loctite Threadlocker

PICTURES SHOWN ARE OF THE CHROME PARTS. INSTALLATION OF THE CHROME & BLACK PARTS WILL BE THE SAME.

NOTICE THESE INSTALLATION INSTRUCTIONS CONTAIN IMPORTANT INFORMATION. ENSURE THE END USER RECEIVES THIS COPY AND IS AWARE OF ITS IMPORTANCE FOR FUTURE USE.

- STEP 1** Read and understand all steps in the instructions before starting the installation. Park the motorcycle on a hard, level surface and turn off the ignition. Let motorcycle cool. Remove main fuse.

WARNING THE END USER'S SAFETY DEPENDS UPON PROPER INSTALLATION OF THIS PRODUCT. IF A STEP IN THESE INSTRUCTIONS IS NOT WITHIN YOUR CAPABILITIES OR YOU DO NOT HAVE THE CORRECT TOOLS, HAVE YOUR DEALER PERFORM THE PROCEDURE. IMPROPER INSTALLATION OF THIS PRODUCT COULD RESULT IN DEATH OR SERIOUS INJURY.

ACCIDENTAL VEHICLE START-UP COULD CAUSE DEATH OR SERIOUS INJURY, REMOVE THE MAIN FUSE BEFORE PROCEEDING.

INSTALLATION REQUIRES CONTACT WITH THE ENGINE AND EXHAUST SYSTEM; ENSURE THAT THEY HAVE FULLY COOLED BEFORE BEGINNING TO PREVENT INJURY.

APPLY BLUE LOCTITE THREADLOCKER TO EACH BOLT, INCLUDING BREATHER BOLTS, DURING THE INSTALLATION PROCESS. DO NOT PRE-APPLY LOCTITE TO BOLTS; ONLY APPLY RIGHT BEFORE INSTALLING THEM.



INSTALLATION INSTRUCTIONS

HYPERCHARGER™ ES FOR SPORTSTER, CHROME & BLACK

9352

-CONTINUED-

STEP 2 Refer to PIC 2. Remove the left side cover to gain access to battery, and the seat if applicable.



STEP 3 Refer to PIC 3. Remove existing air cleaner assembly and hardware. Set it aside, it will not be reused. Ensure that the intake flange of the throttle body is clean and dry.



STEP 4 Locate and disconnect the motorcycle's ignition coil connector.

Note: Refer to your motorcycle's service manual for assistance.

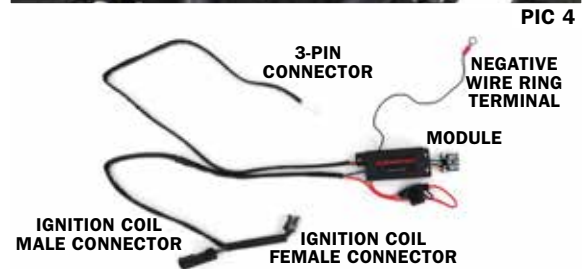

STEP 5 Refer to PIC 4. Locate provided controller.

STEP 6 Refer to PIC 5. Feed the controller's ignition coil connectors wire along the frame of the bike and over the cylinder heads.

STEP 7 Refer to PIC 6. Connect the controller's ignition coil connectors (male and female) to the motorcycle's connectors that were disconnected in Step 4.

Note: The tank may have to be loosened and lifted in the front to gain access to the motorcycle's ignition coil connectors.

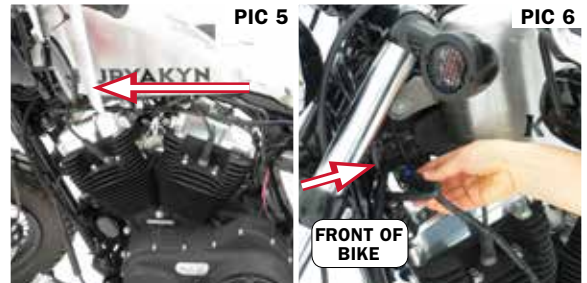

STEP 8 Refer to PIC 7 and 8. Unfasten the screw secured to the battery's negative terminal, and set any connected wires safely away from the battery. Locate the controller's Negative Wire Ring Terminal. Fasten the controller's negative ring terminal, and any other wires that were previously connected, to the battery's negative.

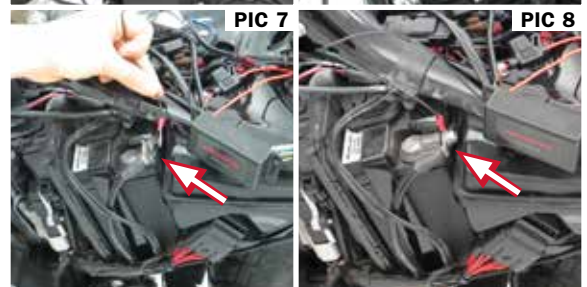

KURYAKYN.COM

INSTALLATION INSTRUCTIONS

HYPERCHARGER™ ES FOR SPORTSTER, CHROME & BLACK

9352

-CONTINUED-

STEP 9 Refer to PIC 9. Feed the controller's 3-pin connector wire through an open slot of the frame, under the seat area. Position the wire over the top of the rear cylinder head and down and behind the throttle body. Do not tie these wires off to the frame or other cables just yet.

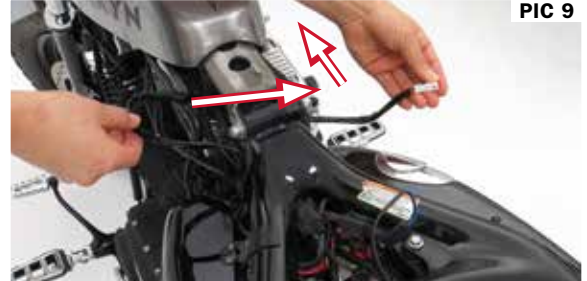

PIC 9

STEP 10 Set the whole controller within a safe open space located in the frame under the left cover area.

Note: The 6-pin connector, located on the opposite side from all of the other wires, does not connect to anything. It can be wrapped in electrical tape and tucked off to the side with the rest of the module.

STEP 11 Refer to PIC 10 through 12. Locate provided Breather Manifold, Front Gasket, and Back Gasket. Align and place front gasket on the front of the breather manifold, and the back gasket on the back of the gasket. Be sure that the holes of the gasket align with, but do not cover, the three holes on the manifold.



PIC 10

BREATHER MANIFOLD

PIC 11

PIC 12

STEP 12 Refer to PIC 13. Locate provided two (2) Breather Bolts, two (2) O-rings, and two (2) Rubber Coated Washers.

STEP 13 On the front side of the Breather Manifold, press the O-rings into the indented circles located in each of the mounting holes of the Manifold.

STEP 14 Apply a small amount of blue Loctite to Breather Bolts. Insert the Breather Bolts through the Manifold. Ensure the bolts capture the O-rings.

STEP 15 On the back side of the Breather Manifold, place the Rubber Coated Washers over the end of the Bolts.

STEP 16 Refer to PIC 14 through 16. Align and fasten the Breather Manifold assembly to the cylinder heads with the Breather Bolts; ensure the O-rings remain in place.

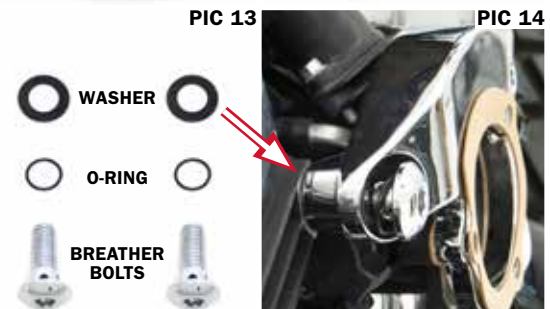

PIC 13

PIC 14

WASHER

O-RING

BREATHER BOLTS

Determine if additional Rubber Coated Washers are necessary to take up any remaining space between the breather legs and cylinder heads. If none are necessary skip to STEP 17.

Carefully remove the Breather Bolts; add Washers as required. Again, ensure that the O-Rings and Gasket remain in place; tighten the Breather Bolts.

Note: Make sure the controller's 3-pin connector wire is position behind the installed Breather Manifold.



PIC 15

PIC 16

KURYAKYN.COM

INSTALLATION INSTRUCTIONS

HYPERCHARGER™ ES FOR SPORTSTER, CHROME & BLACK

9352

-CONTINUED-

STEP 17 Refer to FIG 1. Locate the provided Hypercharger ES Air Cleaner assembly. Dismantle the air cleaner assembly. Make note as to how it is assembled, it will help for reassembly.

- Remove two (2) outside edge screws from cone, and loosen the two (2) inside edge screws
- Remove the cover by pushing it to the left
- Remove two (2) screws and two (2) washers attaching the air filter
- Remove air filter from backer plate assembly

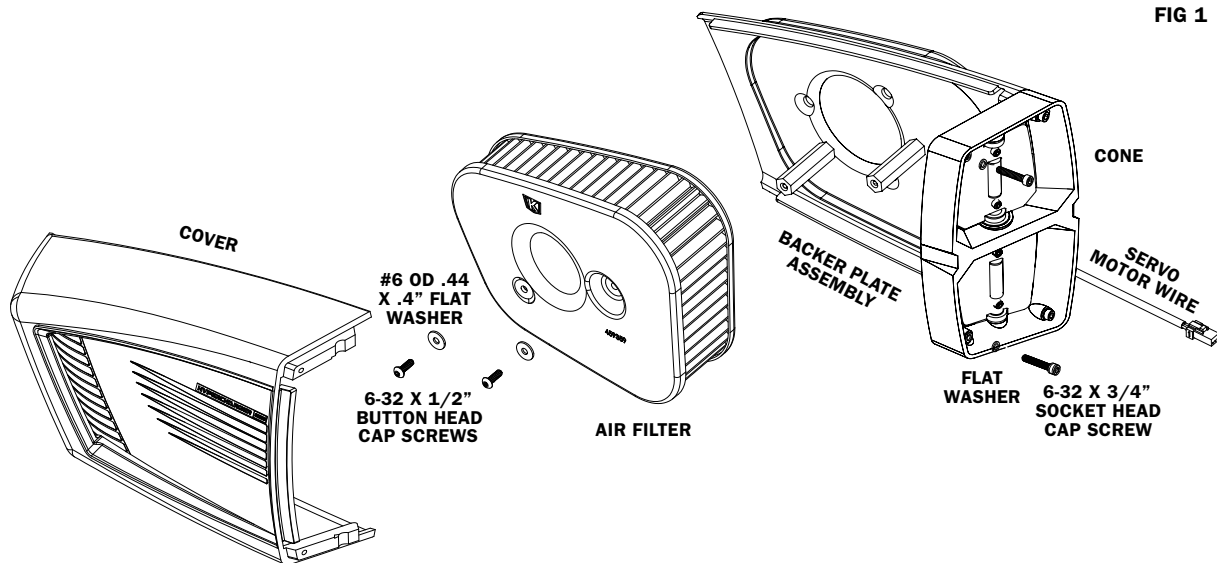
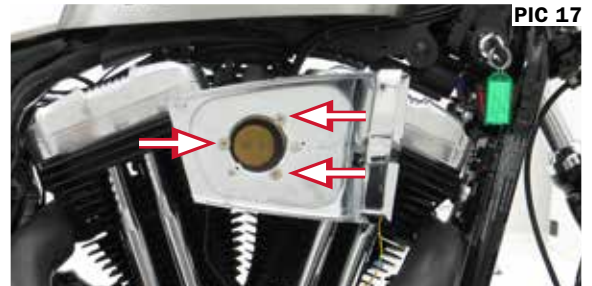

FIG 1

STEP 18 Refer to PIC 17. Locate provided three (3) 1/4-20 x 1\" Flat Head Socket Cap Screws. Align the Backer Plate mounting holes with the Breather Manifold. Insert the screws into the mounting holes of the Backer Plate and fasten it to the manifold. Fully tighten hardware.

TORQUE VALUE FOR BACKPLATE SCREWS:
40-60 IN-LBS (4.5-6.8 NM)



PIC 17

STEP 19 Refer to PIC 18 and 19. Locate the Air Filter and two (2) Button Head Cap Screws and (2) Washers that were removed in Step 17. Place the washers onto the screws. Apply a small amount of blue Loctite to screws. Align the air filter mounting holes with the Backer Plate stand offs. Fasten the Air Filter to the Backer Plate by using the screw and washer combos. Fully tighten hardware.

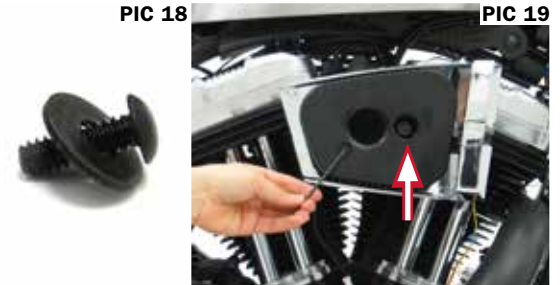

PIC 18

PIC 19

INSTALLATION INSTRUCTIONS

HYPERCHARGER™ ES FOR SPORTSTER, CHROME & BLACK

9352

-CONTINUED-

- STEP 20** Refer to PIC 20 and 21. Locate the Cover. Be aware that there is a tab located on the left back side of the cover that will align with a notch on the left back side of the backer plate.

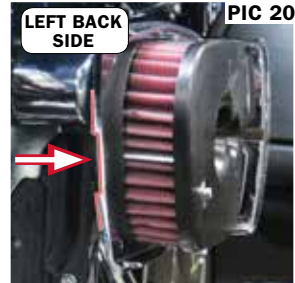

- STEP 21** Refer to PIC 22. Slide the cover over the air filter assembly starting from the back side of the bike and pushing it towards the front of the bike. Be sure the tab of the cover is seated properly in the notch of the backer plate. Push the cover forward. There should be a little gap between the cover and the cone of the assembly.

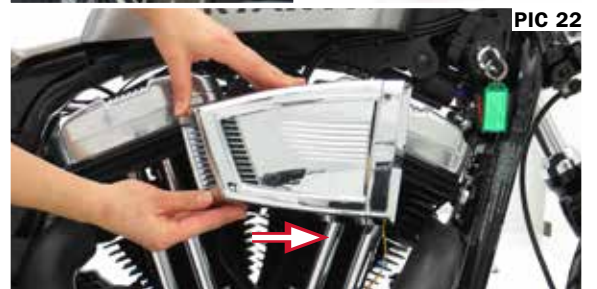

- STEP 22** Refer to PIC 23 and 24. Locate the two (2) socket head cap screws that were removed in Step 17. Apply a small amount of blue Loctite to screws. Insert the screws into the outside edge holes of the cone. As you tighten the screws the cover should pull forward, closing the gap between the cone and cover. Fully tighten all four (4) screws in the cone.

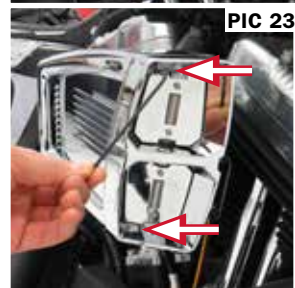

- STEP 23** Refer to PIC 25. Connect the Hypercharger's servo motor connector with the controller's 3-pin connector. Use the provided 6" cable ties to fasten the controller's wires to other secure cables or the frame of the bike to secure the wires out of the way.



NOTICE

SECURE THE WIRING AWAY FROM MOVING PARTS, PINCH POINTS, OR EXTREME HEAT. KURYAKYN WILL NOT PROVIDE WARRANTY COVERAGE ON ANY ELECTRICAL COMPONENT THAT FAILS DUE TO PINCHED, CRIMPED, BROKEN, ABRADED, MELTED, OR FRAYED WIRES.

- STEP 24** Reinstall main fuse. Turn ignition on and test newly installed Hypercharger ES air cleaner. Turn ignition off.



- STEP 25** Reinstall left cover, and the seat if applicable.

KURYAKYN.COM

866 277 9598 | INFO@KURYAKYN.COM
454 COUNTY ROAD VV SOMERSET, WI 54025

INSTALLATION INSTRUCTIONS

HYPERCHARGER™ ES FOR SPORTSTER, CHROME & BLACK

9352

-CONTINUED-

NOTICE

IT IS THE INSTALLER'S RESPONSIBILITY TO ENSURE THAT ALL OF THE FASTENERS (INCLUDING PRE-ASSEMBLED) ARE TIGHTENED BEFORE OPERATION OF THE MOTORCYCLE. KURYAKYN WILL NOT PROVIDE WARRANTY COVERAGE ON PRODUCTS OR COMPONENTS LOST DUE TO IMPROPER INSTALLATION OR LACK OF MAINTENANCE. PERIODIC INSPECTION AND MAINTENANCE ARE REQUIRED ON ALL FASTENERS.

LIMITED WARRANTY

Kuryakyn warrants that any Kuryakyn products sold hereunder, shall be free of defects in materials & workmanship for a period of one (1) year from the date of purchase by the consumer excepting the following provisions:

1. Kuryakyn shall have no obligation in the event the customer is unable to provide a receipt showing the date the customer purchased the product(s).
2. The product must be properly installed, maintained & operated under normal conditions.
3. Kuryakyn shall not be liable for any consequential & incidental damages, including labor & paint, resulting from failure of a Kuryakyn product, failure to deliver, delay in delivery, delivery in nonconforming condition, or for any breach of contract or duty between Kuryakyn & a customer.
4. Kuryakyn products are often intended for use in specific applications. Kuryakyn makes no warranty if a Kuryakyn product is used in applications other than intended.
5. Kuryakyn electrical products are warranted for one (1) year from the date of purchase by the consumer. L.E.D.'s contained in components of Kuryakyn products will be warranted for defects in materials & workmanship for 3 years from the date of purchase whereas all other components shall be warranted for one (1) year.
6. All warranty claims must be directed to the place of purchase. Merchandise sold through internet auction sites or any other unauthorized reseller shall not carry a Kuryakyn warranty. If unsure, please contact the place of purchase to verify they are an authorized Kuryakyn reseller.

RETURN POLICY

Merchandise determined to be defective may be returned up to one year from the date of purchase. Returns must be processed through original seller. Returned merchandise for any other reason other than warranty claims must be in like new condition & subject to a 20% restocking fee. All returns are subject to inspection for determination of full or partial credit. Any returned part that shows evidence of being used or installed contrary to manufacturer's instructions, &/or subjected to improper handling, packaging or return shipping by the customer, will not be eligible for exchange, refund or warranty consideration. All returned electrical items will be inspected & tested. If electrical item is deemed functional, no credit will be issued & item will be returned. All sales are final on discontinued or closeout merchandise.

©2015 KURYAKYN HOLDINGS, LLC ALL RIGHTS RESERVED

KURYAKYN, KURYAKYN K logo and the marks appearing on this instruction sheet are registered and common law trademarks of Kuryakyn Holdings except noted third-party trademarks. A full listing of trademarks and trademark registrations owned by Kuryakyn Holdings can be found at www.kuryakyn.com/legal-notice.

Emissions Notice: The California Air Resources Board (CARB) does not permit the use of aftermarket emission-related parts(s) that alter the performance of OEM emission-related devices unless CARB has issued an Executive Order, other than on racing vehicles on closed courses. Check your local laws and manufacturer's information.

Listed Manufacturers and product model names are for reference only. All product and company names are trademarks or registered trademarks of their respective holders. Use of them does not imply any affiliation with or endorsement by them. All specifications are subject to change without notice.

For additional information on third-party product and company names, please consult our Web page at www.kuryakyn.com/legal-notice