

SENA



STRYKER

MOTORCYCLE BLUETOOTH® HELMET
WITH MESH INTERCOM™

————— SOUND BY —————
harman/kardon®

USER'S GUIDE

Version 1.0.0

ENGLISH

TABLE OF CONTENTS

1.	ABOUT THE STRYKER	8
1.1	Product Features	8
1.2	General Information	9
1.3	Product Details	10
1.4	Detachable Inner Parts	11
1.5	Package Contents	12
1.6	Ventilation	12
2.	WEARING THE HELMET	13
2.1	Putting on the Helmet	13
2.2	Removing the Helmet	13
2.3	Removing the Shield Visor	14
2.4	Installing the Shield Visor	14
2.5	Removing the Breath Guard	15
2.6	Installing the Breath Guard	15
2.7	Replacing the Ear Cups	15
2.8	Removing the Cheek Pads	16
2.9	Installing the Cheek Pads	16
2.10	Removing the Inner Pad	17
2.11	Installing the Inner Pad	17
2.12	Removing the Inner Sun Visor	18
2.13	Installing the Inner Sun Visor	18
2.14	Pre-Ride Helmet Inspection	19
2.14.1	Checking the Exterior	19
2.14.2	Checking the Chinstrap	19
2.15	Checking the Shield Visor	20

3.	GETTING STARTED	21
3.1	Downloadable Sena Software	21
3.1.1	SENA MOTORCYCLES App	21
3.2	Charging	21
3.3	Legend	22
3.4	Powering On and Off	22
3.5	Checking the Battery Level	22
3.6	Volume Adjustment	22
4.	PAIRING THE BLUETOOTH SYSTEM WITH OTHER BLUETOOTH DEVICES	23
4.1	Phone Pairing	23
4.1.1	Initially Pairing the Stryker	23
4.1.2	Pairing When the Stryker is Turned Off	24
4.1.3	Pairing When the Stryker is Turned On	25
4.2	Second Mobile Phone Pairing - Second Mobile Phone, GPS, and SR10	25
4.3	Advanced Selective Pairing: Hands-Free or A2DP Stereo	26
4.3.1	Phone Selective Pairing - Hands-Free Profile	26
4.3.2	Media Selective Pairing - A2DP Profile	26
4.4	GPS Pairing	27
5.	MOBILE PHONE USAGE	28
5.1	Making and Answering Calls	28
5.2	Siri and Google Assistant	28
5.3	Speed Dialing	28
5.3.1	Assigning Speed Dial Presets	28
5.3.2	Using Speed Dial Presets	29

6.	STEREO MUSIC	30
6.1	Bluetooth Stereo Music	30
6.2	Music Sharing	30
6.2.1	Bluetooth Intercom Music Sharing	31
6.2.2	Mesh Intercom Music Sharing	31
7.	MESH INTERCOM	32
7.1	What is Mesh Intercom?	32
7.1.1	Open Mesh	33
7.1.2	Group Mesh	33
7.2	Starting Mesh Intercom	34
7.3	Using the Mesh in Open Mesh	34
7.3.1	Channel Setting (Default: channel 1)	34
7.4	Using Mesh in Group Mesh	35
7.4.1	Creating a Group Mesh	35
7.4.2	Joining an Existing Group Mesh	36
7.5	Enable/Disable Mic (Default: Enable)	37
7.6	Toggling Open Mesh/Group Mesh	37
7.7	Reset Mesh	37
8.	BLUETOOTH INTERCOM	38
8.1	Intercom Pairing	38
8.1.1	Using the Smart Intercom Pairing (SIP)	38
8.1.2	Using the Button	39
8.2	Last-Come, First-Served	40
8.3	Two-Way Intercom	41
8.4	Multi-Way Intercom	42
8.4.1	Starting a Three-Way Intercom Conference	42
8.4.2	Starting a Four-Way Intercom Conference	43
8.4.3	Ending Multi-Way Intercom	43

8.5	Three-Way Conference Phone Call with Intercom Users	44
8.6	Group Intercom	45
8.7	Mesh Intercom Conference with Bluetooth Intercom Participant	45
9.	UNIVERSAL INTERCOM	47
9.1	Universal Intercom Pairing	47
9.2	Two-Way Universal Intercom	47
9.3	Multi-Way Universal Intercom	48
9.3.1	Three-Way Universal Intercom	48
9.3.2	Four-Way Universal Intercom	49
9.4	Mesh Intercom Conference with Two-way Universal Intercom Participant	50
10.	USING THE FM RADIO	51
10.1	FM Radio On/Off	51
10.2	Seek and Save Radio Stations	51
10.3	Scan and Save Radio Stations	52
10.4	Temporary Station Preset	52
10.5	Navigating Preset Stations	53
11.	LED TAILLIGHT	54
12.	VOICE COMMAND	55
13.	FUNCTION PRIORITY	57

14. FIRMWARE UPGRADES	58
14.1 Wi-Fi-Enabled for Automatic Firmware Update	58
14.1.1 Connecting to the Bluetooth System	58
14.1.2 Connection Setup	59
14.1.3 LED Description	59
14.1.4 Wi-Fi Reset	60
15. CONFIGURATION SETTING	61
15.1 Bluetooth System Configuration Menu	61
15.1.1 Delete All Pairings	62
15.1.2 Remote Control Pairing	62
15.2 Software Configuration Setting	62
15.2.1 Headset Language	62
15.2.2 Audio Equalizer (Default: Music Balance)	63
15.2.3 VOX Phone (Default: Enable)	63
15.2.4 VOX Intercom (Default: Disable)	63
15.2.5 VOX Sensitivity (Default: 3)	64
15.2.6 HD Intercom (Default: Enable)	64
15.2.7 HD Voice (Default: Enable)	64
15.2.8 Bluetooth Intercom Audio Multitasking (Default: Disabled)	65
15.2.9 Intercom-Audio Overlay Sensitivity (Default: 3)	65
15.2.10 Audio Overlay Volume Management (Default: Disable)	65
15.2.11 Smart Volume Control (Default: Disable)	66
15.2.12 Sidetone (Default: Disable)	66
15.2.13 Voice Prompt (Default: Enable)	66
15.2.14 RDS AF Setting (Default: Disable)	66
15.2.15 FM Station Guide (Default: Enable)	66
15.2.16 Advanced Noise Control™ (Default: Enable)	66
15.2.17 Region Selection	67

16. TROUBLESHOOTING	68
16.1 Fault Reset	68
16.2 Factory Reset	68
17. MAINTENANCE AND CARE	69
17.1 Outer Shell	69
17.2 Inner Lining	69
17.3 Storing the Helmet	69

1. ABOUT THE STRYKER

1.1 Product Features



Bluetooth® 5.0



Mesh Intercom™ up to 2 km (1.2 mi)*



Intercom up to 2 km (1.2 mi)*



Audio Multitasking™



- Multi-Language Voice Command
- Support Siri and Google Assistant



Wi-Fi-Enabled for Automatic Firmware Updates

* in open terrain

1.2 General Information

This product is a Motorcycle Sports Touring Full-Face Helmet.

Do not use it for any other purpose than riding a motorcycle. If you use the helmet for anything else, it may not provide sufficient protection in an accident. No helmet can protect the wearer against all possible impact scenarios.

For maximum protection, the helmet must fit properly on the head and its retention strap securely fastened under the chin. With the retention system comfortably but firmly adjusted, the helmet should allow sufficient peripheral vision when secured. If the helmet is too large, it may move on your head while riding. If the helmet can be removed when pulled from the back in an upward and forward direction, it's not fitted properly. This could cause the helmet to obstruct your vision while riding or come off in an accident, resulting in personal injury or death. Please refer to **Section 2: "Wearing the Helmet"** for more details about properly securing and wearing your helmet.

The contents of this helmet User's Guide are subjected to change without notice. Its illustration may differ from the actual product. The copyrights for the User's Guide belong to Sena Technologies, Inc. Reproduction or copying of the User's Guide without permission is strictly prohibited.

1.3 Product Details

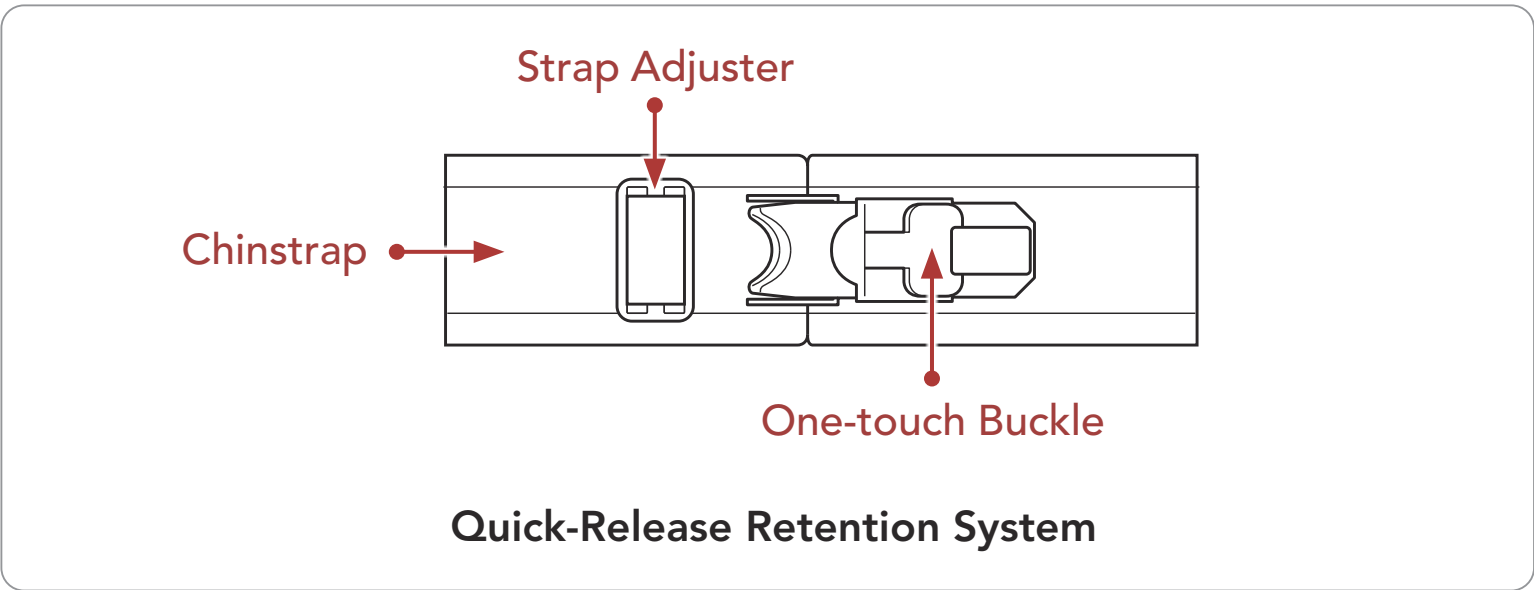
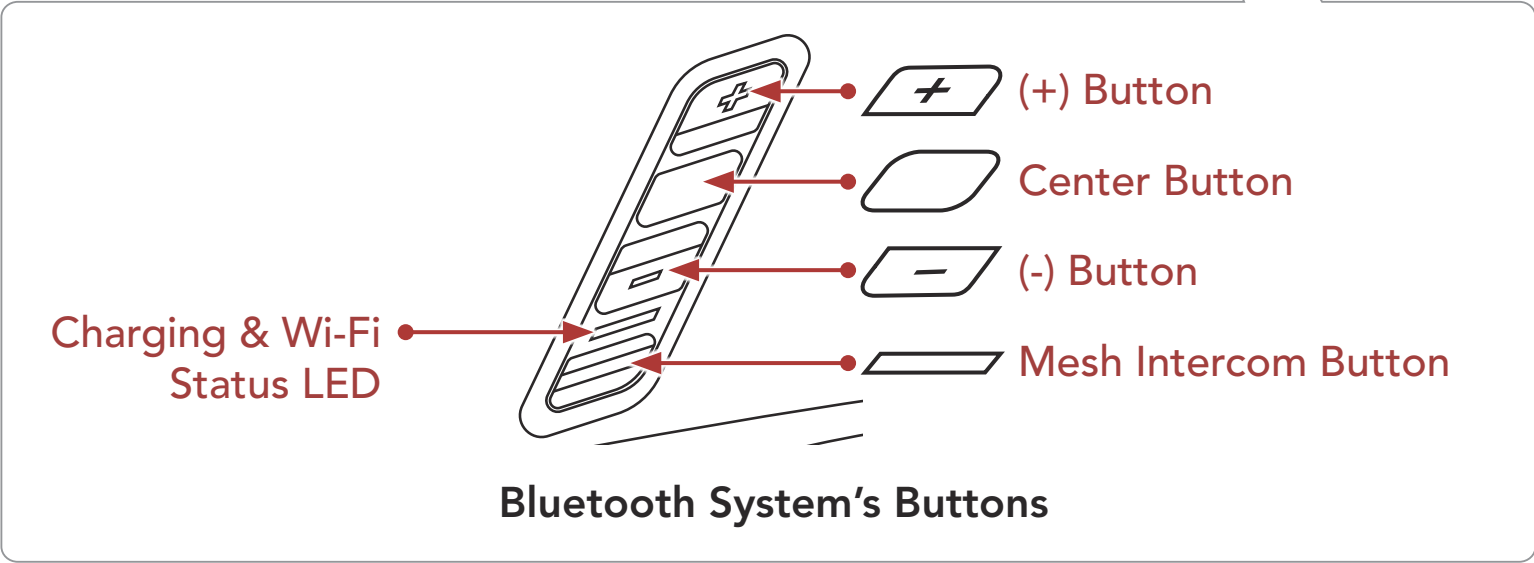
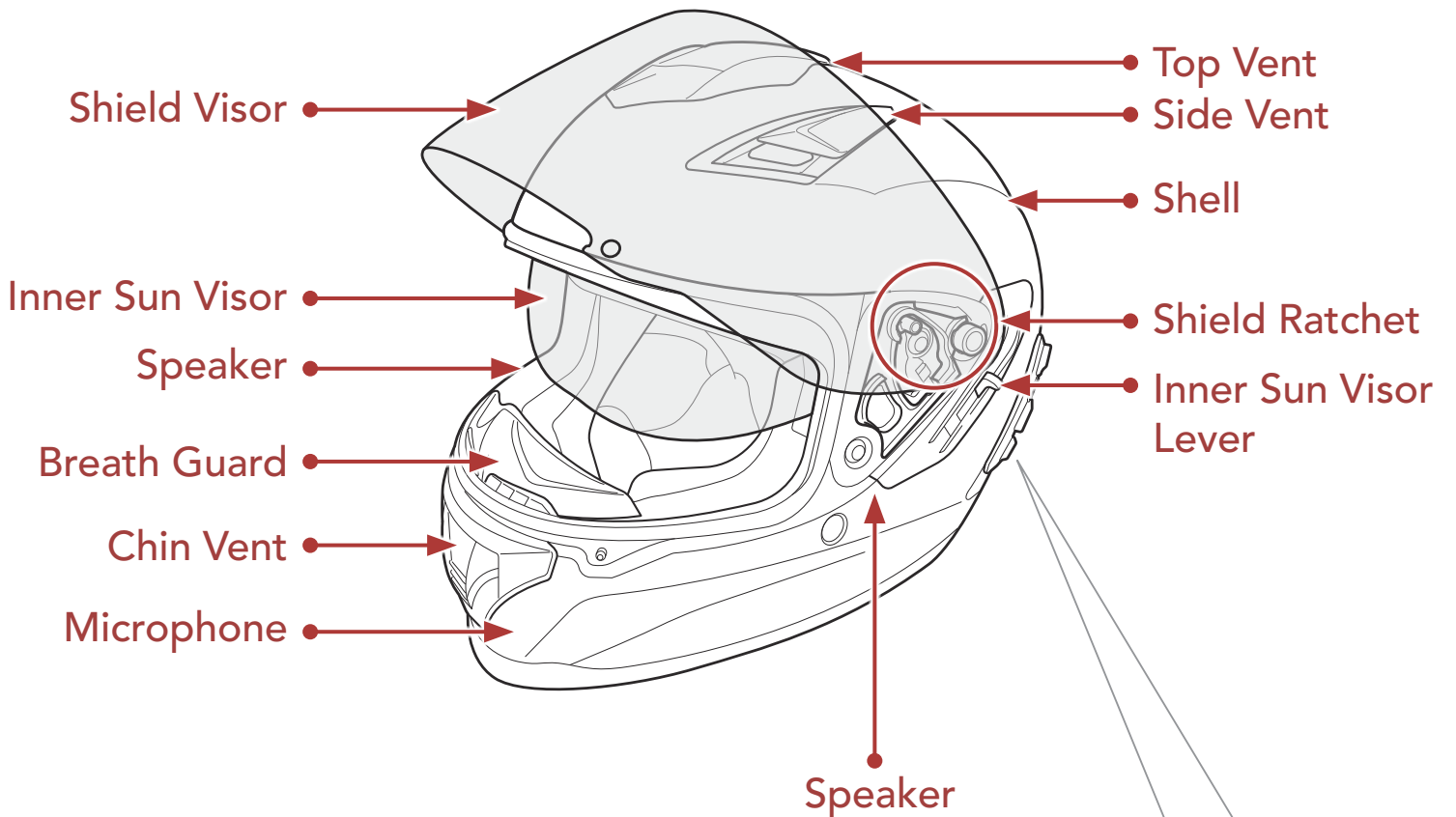

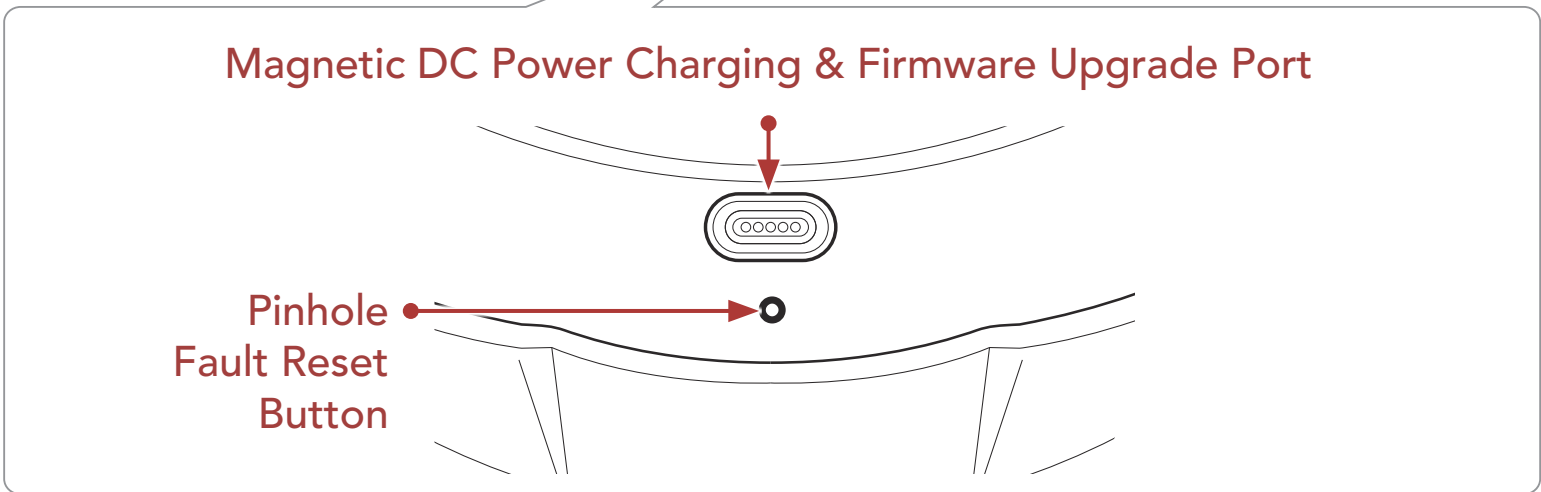
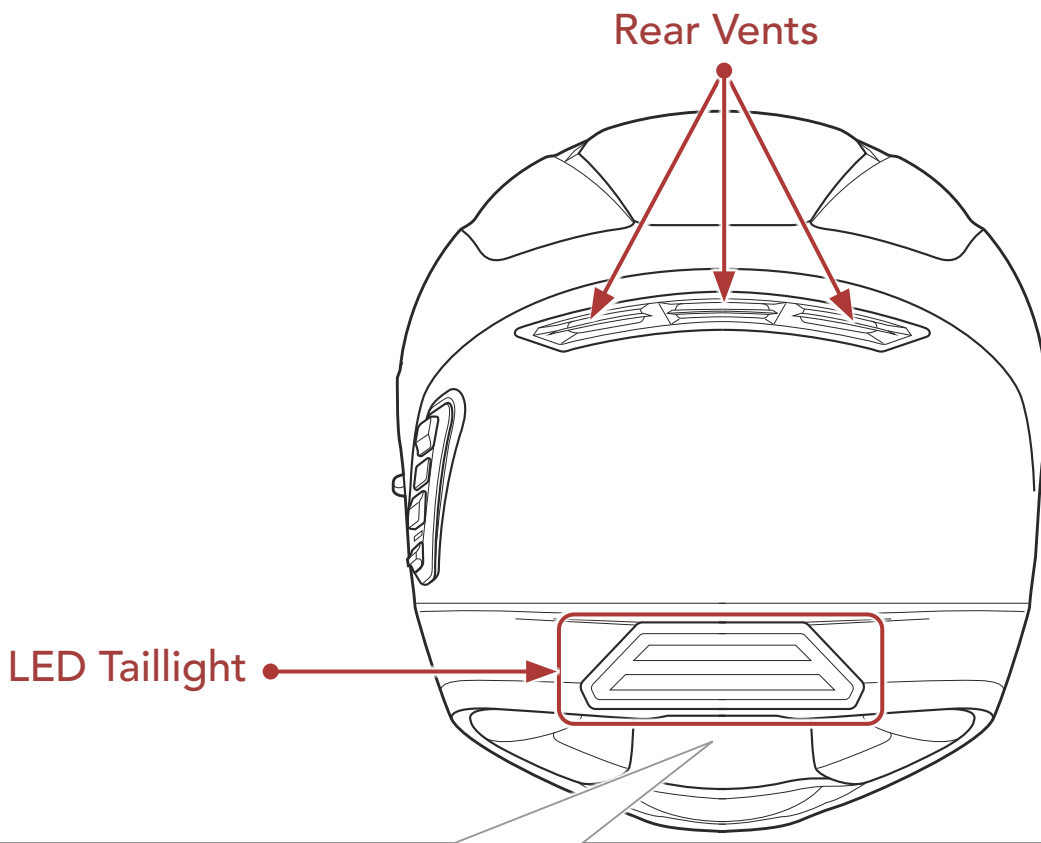

1.4 Detachable Inner Parts

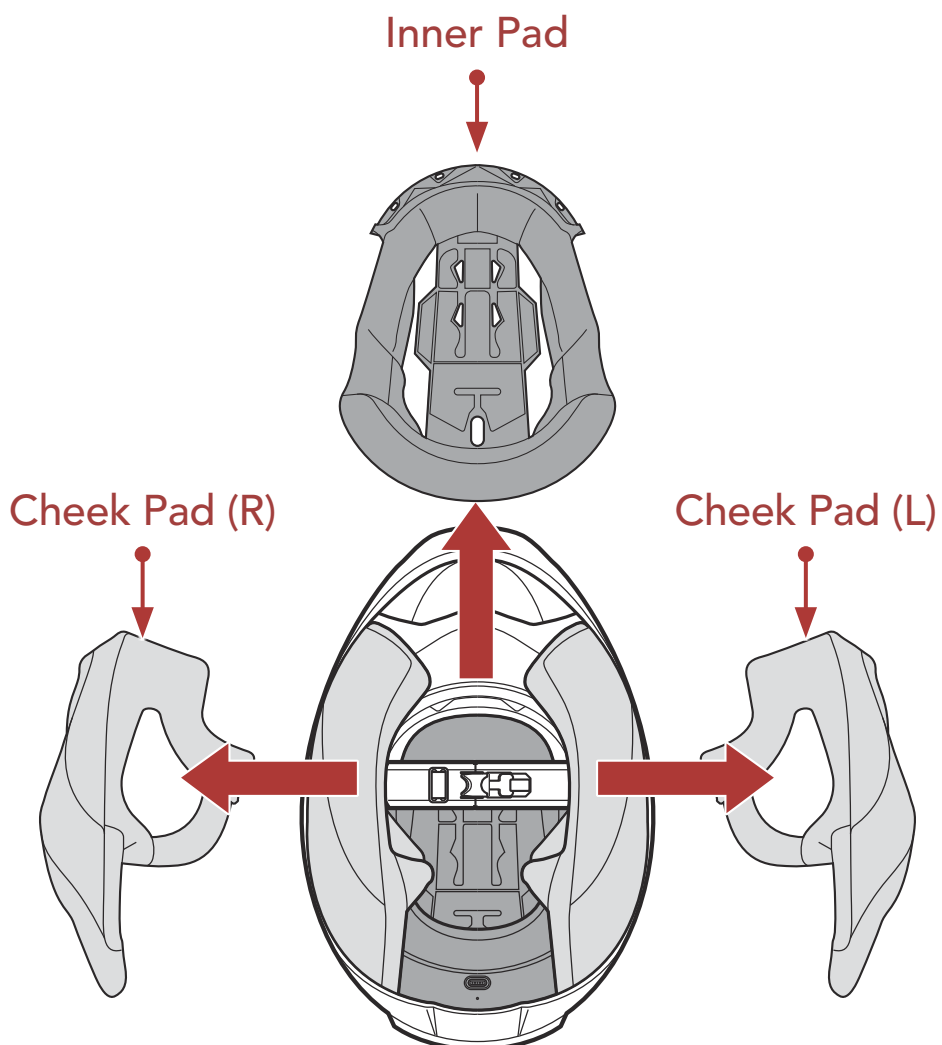

1.5 Package Contents



Stryker Helmet



Helmet Pouch

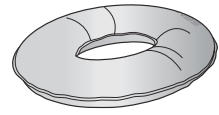

Helmet Stand

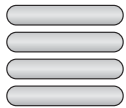

Reflex Stickers (4)*

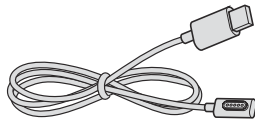

USB Power & Data Cable
(Magnetic USB-C)

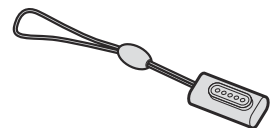

Magnetic
USB-C Adapter

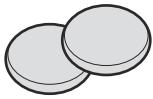

Ear Cups (Thin) (2)

* Included only in Europe package

1.6 Ventilation

Top & Side Ventilation:

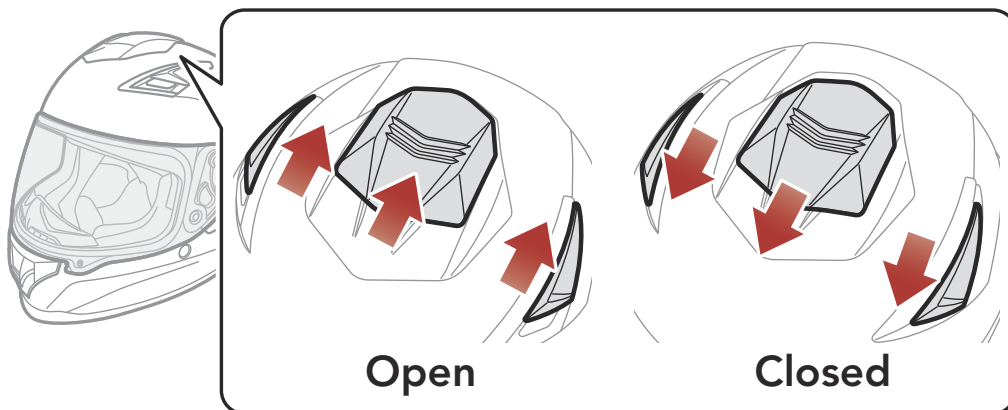

Chin Ventilation:

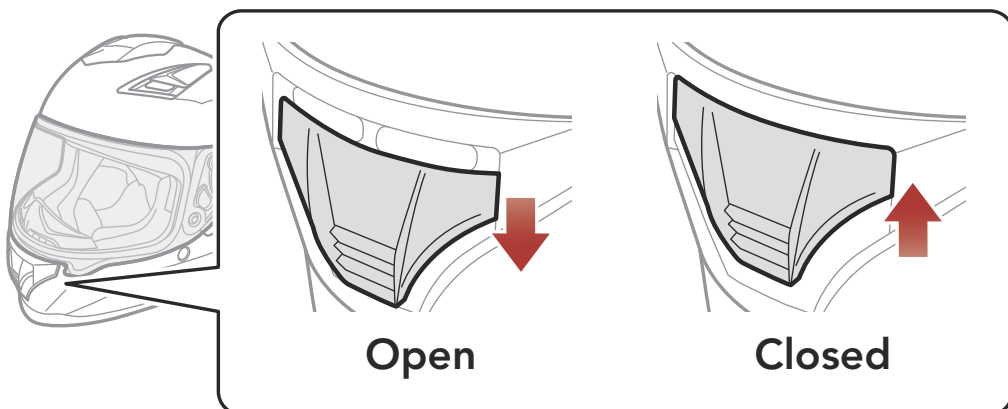

2. WEARING THE HELMET

2.1 Putting on the Helmet

1. Unfasten the chinstrap by using the retention system.
2. Expand the helmet opening with your hand, and slide your head into the helmet.
3. Fasten the chinstrap as tight as possible without causing you pain.

2.2 Removing the Helmet

1. Unfasten the chinstrap by using the retention system.
2. Gently pull the padded chinstrap outward and slide the helmet off your head.

Note: Fastening the chinstrap after removing the helmet will help avoid scratching surfaces it's placed upon.

Quick-release retention system

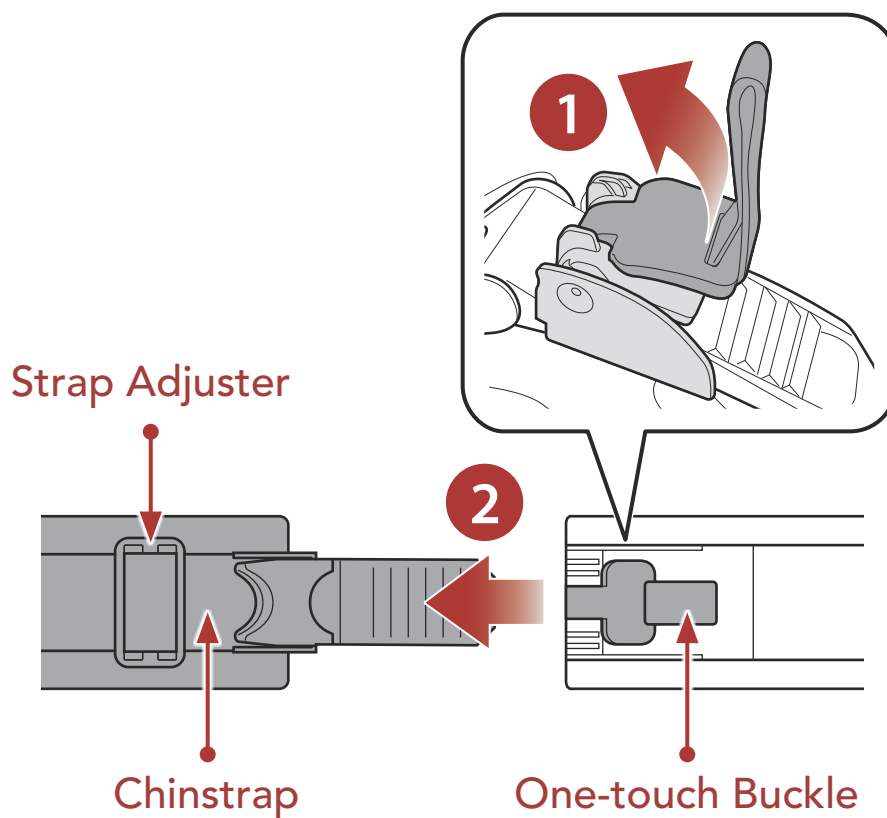

2.3 Removing the Shield Visor

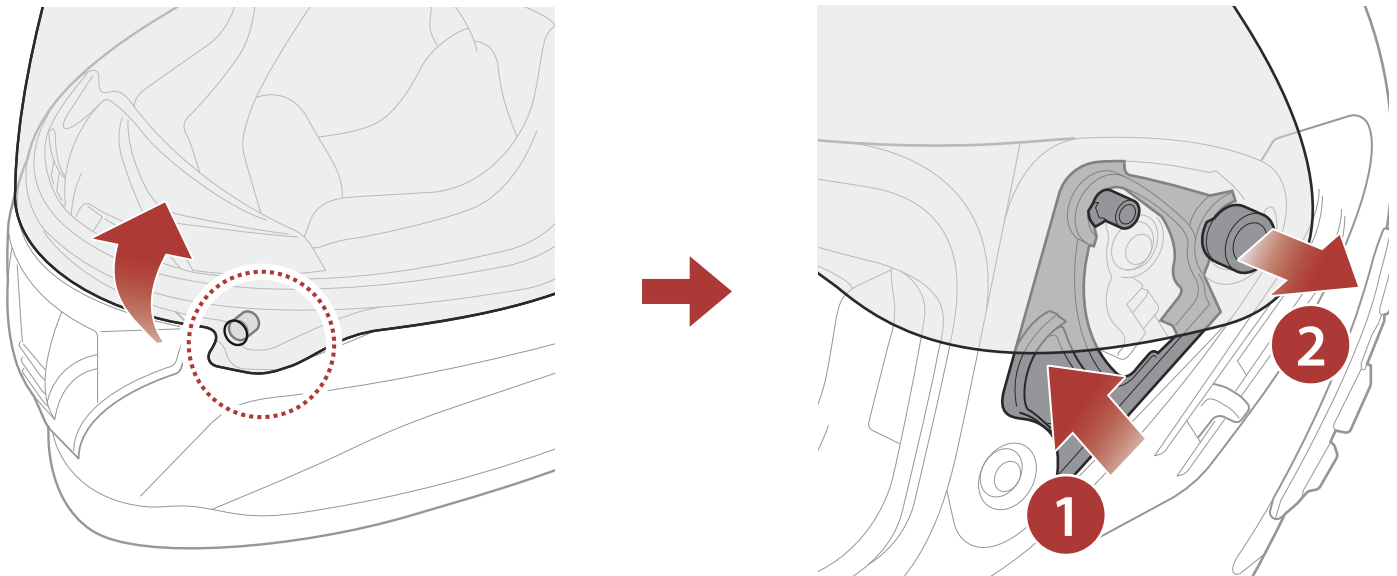

1. Unlatch the tab located on the left side of the shield visor to detach it from the hook.
2. Open the shield visor to the fully opened position.
3. Pull the shield visor outward while pushing the shield ratchet lever upward.
4. Repeat Step 3 on the opposite side.

2.4 Installing the Shield Visor

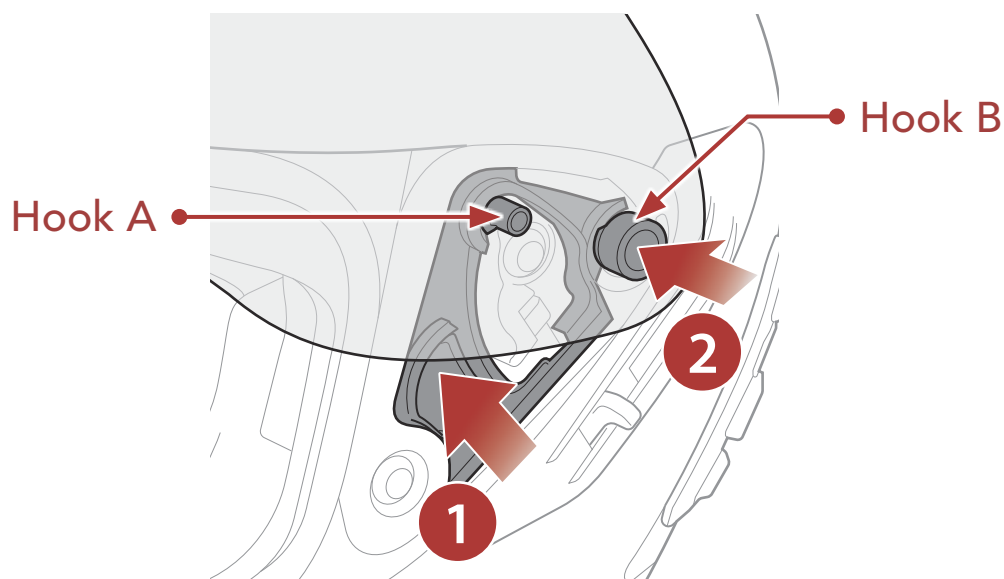

1. Align hooks A and B to the shield ratchet as shown in the illustration above.
2. Insert hooks A and B into the shield ratchet while pushing the shield ratchet lever upward.
3. Release the shield ratchet lever to lock the shield visor into place.
4. Repeat the process on the opposite side.

2.5 Removing the Breath Guard

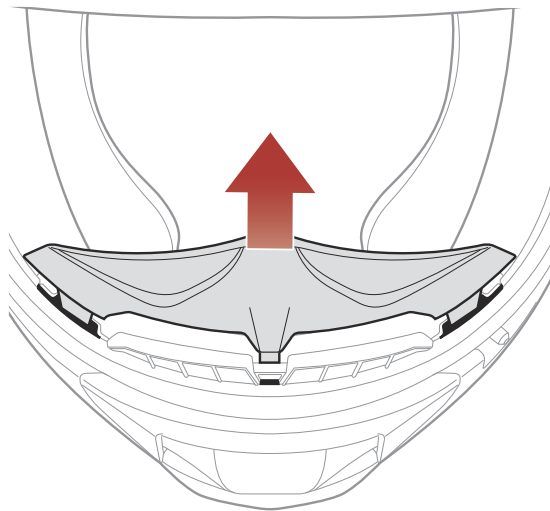

Pull the breath guard away from the chin guard until it separates completely.

2.6 Installing the Breath Guard

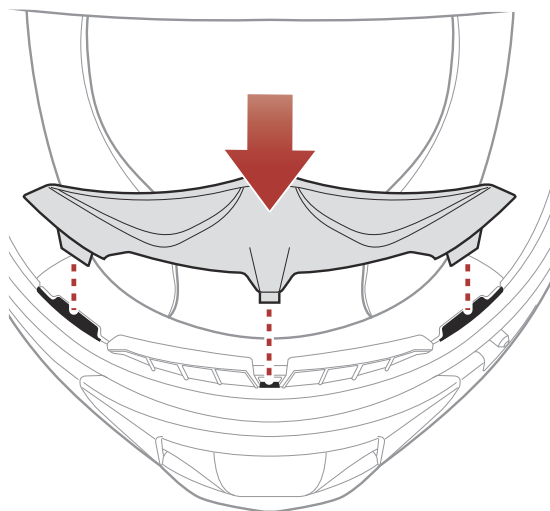

Insert the three tabs of the breath guard into the slots.

2.7 Replacing the Ear Cups

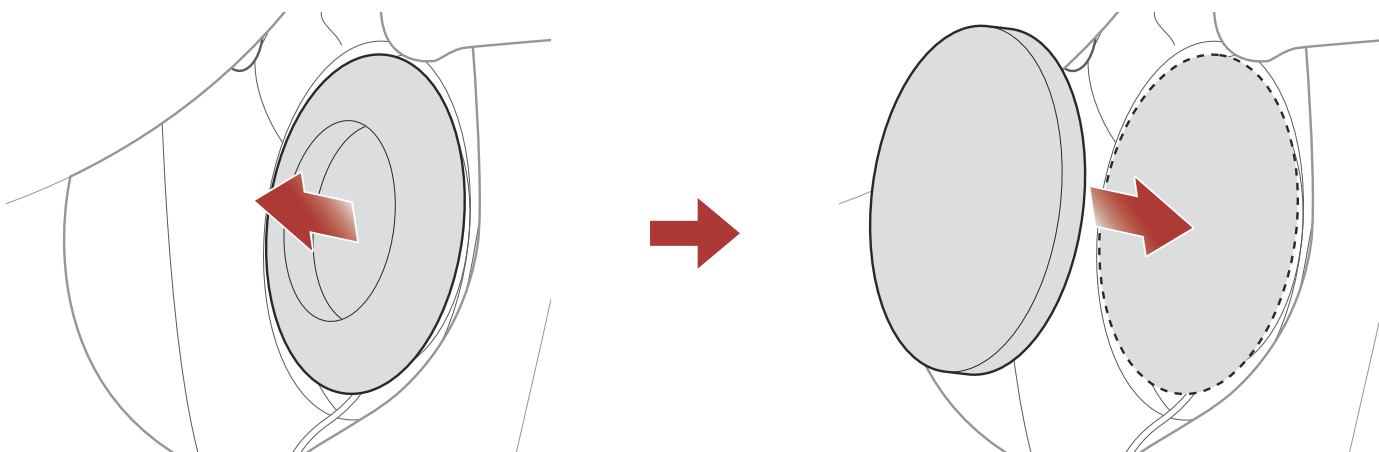

1. Remove one of the ear cups and replace it with the thin ear cup included in the package.
2. Repeat Step 1 on the opposite side.

2.8 Removing the Cheek Pads

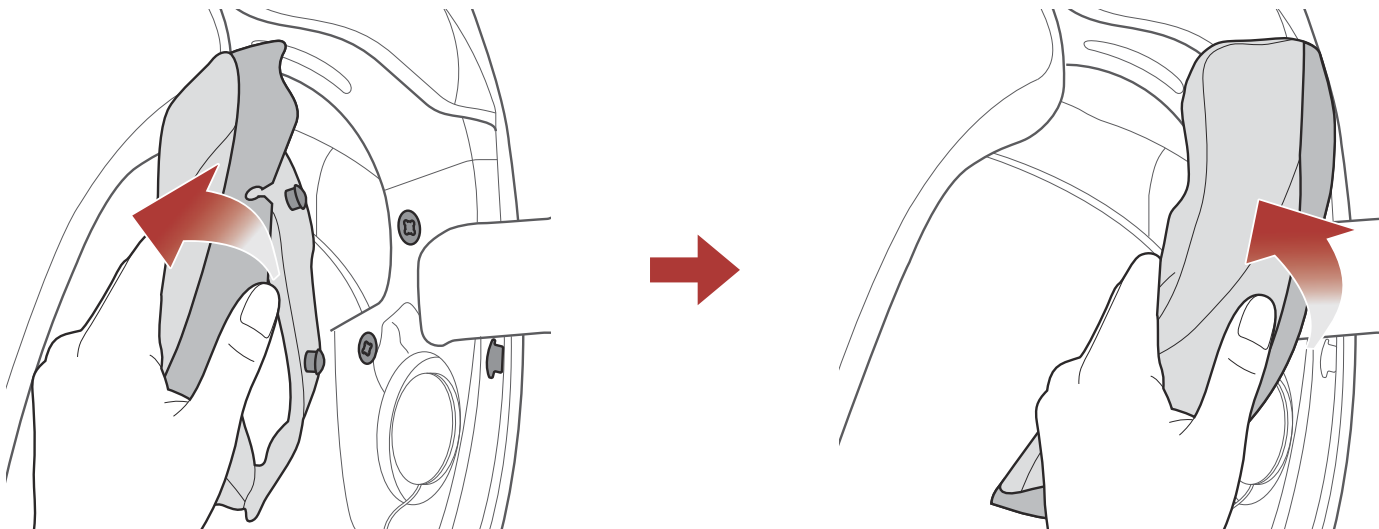

1. Unsnap the two cheek pad fasteners and detach the one hook from the helmet.
2. Remove the cheek pad by pulling it upward.
3. Repeat the process on the opposite side.

2.9 Installing the Cheek Pads

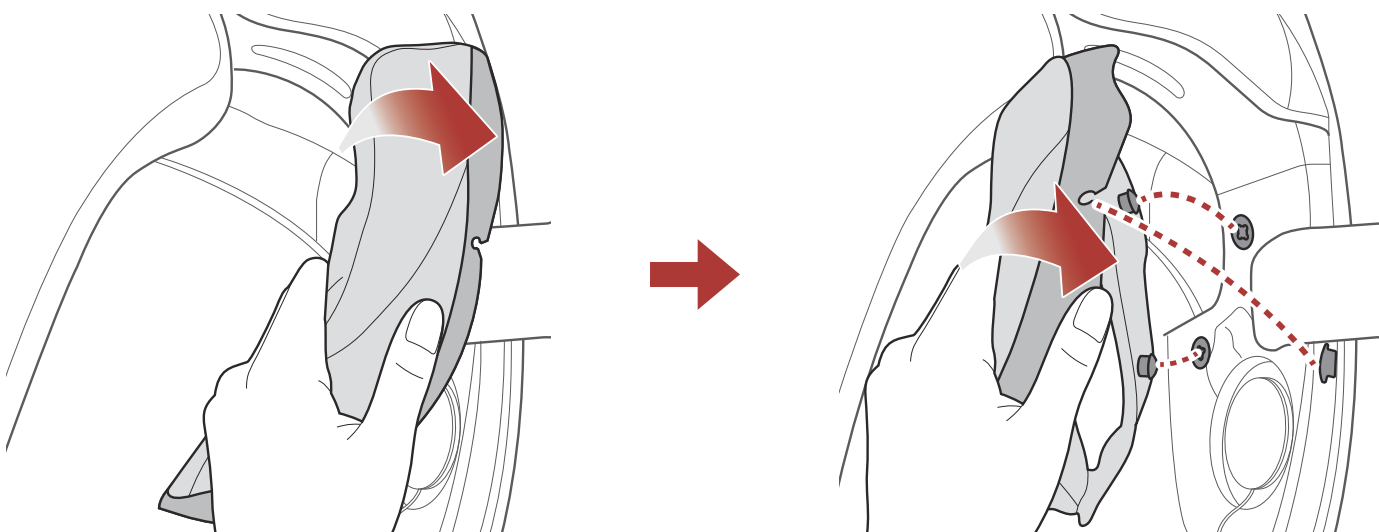

1. Pass the chinstrap through the hole in the cheek pad, and insert the cheek pad's plastic plate into the space between the shell and EPS.
2. Snap the two cheek pad fasteners and engage the one hook into place.
3. Repeat the process on the opposite side.

2.10 Removing the Inner Pad

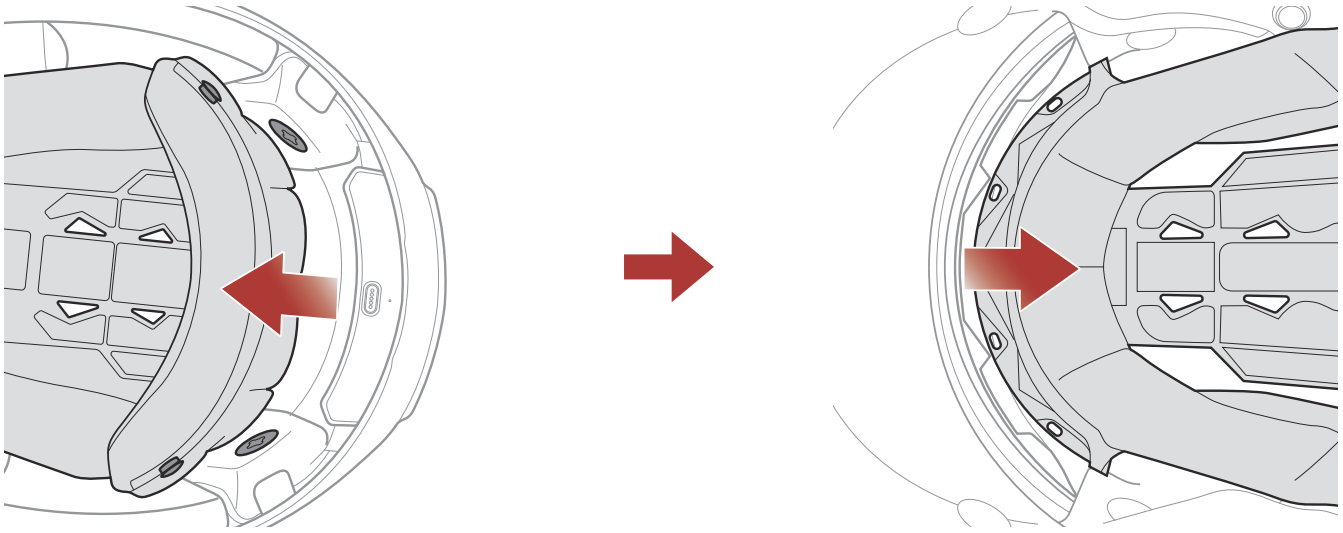

1. Unsnap the two inner pad rear fasteners.
2. Lift the pad upward and place your fingers under the plastic plate in the front section. Then, remove the plate by pulling it away from the front of the helmet.

2.11 Installing the Inner Pad

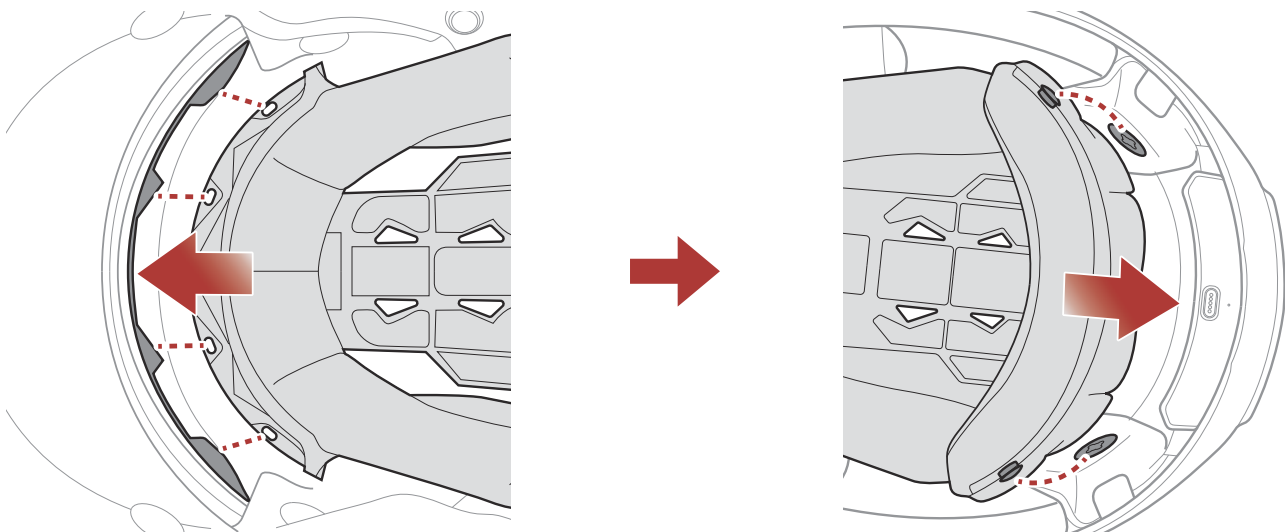

1. Align and install the plastic plate on the four sleeves of the front section.
2. Snap the two inner pad rear fasteners into place.

2.12 Removing the Inner Sun Visor

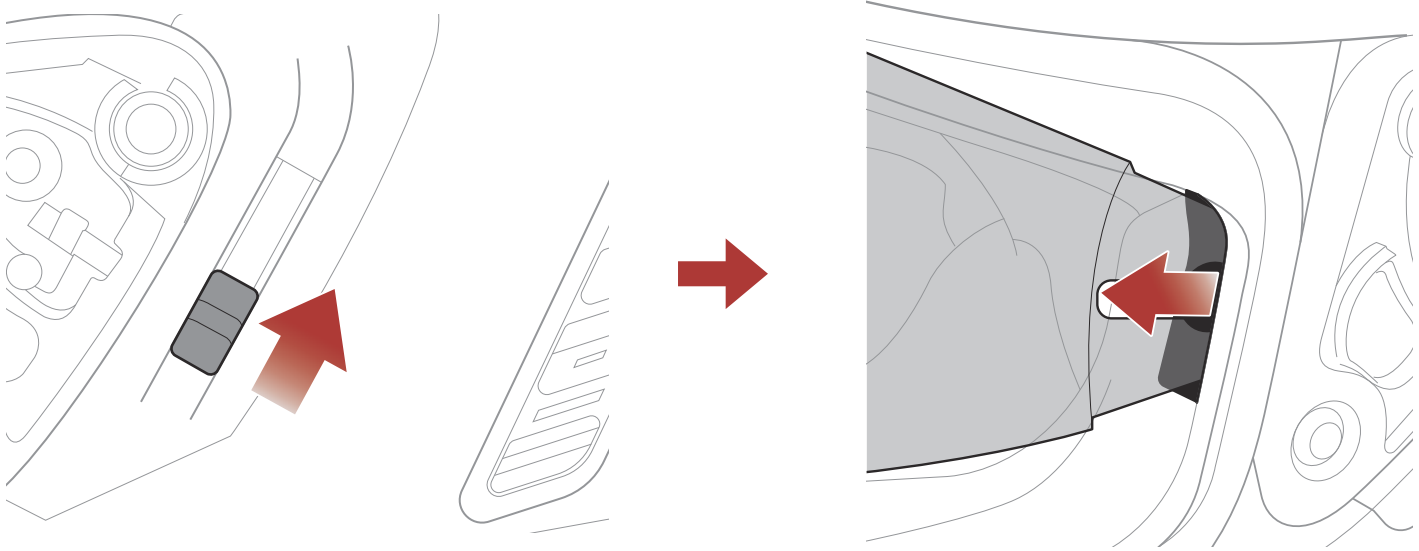

1. Slide the inner sun visor lever in the direction shown in the illustration above to lower the inner sun visor.
2. Pull one side of the visor in the direction shown in the illustration above.
3. Repeat Step 2 on the opposite side.

2.13 Installing the Inner Sun Visor

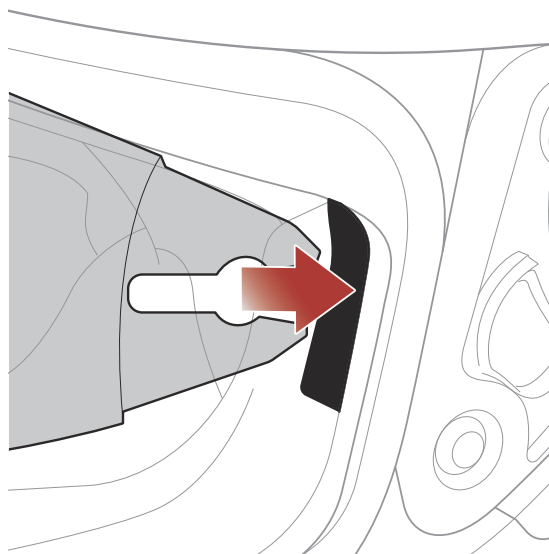

1. Insert the inner sun visor tab into its slot until you hear a click.
2. Repeat Step 1 on the opposite side.

2.14 Pre-Ride Helmet Inspection

⚠ WARNING: This product is a motorcycle helmet. Do not use it for any other purpose than riding a motorcycle. If you use the helmet for anything else, it may not provide sufficient protection in an accident. No helmet can protect the wearer against all possible impact scenarios.

2.14.1 Checking the Exterior

Check the helmet regularly for damage. Small, superficial scratches will not impair the helmet's protective qualities. In the case of more serious damage (cracks, dents, flaking and cracking paint, etc.), the helmet should no longer be used.

2.14.2 Checking the Chinstrap

1. Ensure that the chinstrap is properly routed under your chin.
2. To test the chinstrap tension, slip your index finger under the chinstrap and pull. If the chinstrap is loose under the chin, it needs to be tightened. If the chinstrap loosens when you pull on it, the helmet is not properly fitted. Undo the chinstrap completely and try fastening it again, then repeat the test.
3. If you are unable to fasten the chinstrap so that it fits firmly against the chin, check that your helmet is still the right size for you.

Note: Repeat the test after each adjustment.

⚠ CAUTION: Never ride with the chinstrap unfastened or incorrectly adjusted. The chinstrap should fit correctly and should not become loose when pulled. The fastener is not correctly closed if the chinstrap becomes loose when pulled.

2.15 Checking the Shield Visor

Before every ride, clean the shield visor, check that it functions properly and that its surface is scratch- and crack-free. A malfunctioning, badly scratched or dirty shield will considerably impair your vision and should be replaced before riding.

CAUTION:

- A heavily scratched shield visor considerably interferes with visibility and should be replaced if necessary before riding.
- Stop riding if visibility is poor.

3. GETTING STARTED

3.1 Downloadable Sena Software

3.1.1 SENA MOTORCYCLES App

By simply pairing your phone with your Bluetooth system, you can use the **SENA MOTORCYCLES App** for quicker, easier set up and management.

	SENA MOTORCYCLES <ul style="list-style-type: none">• Wi-Fi-Enabled for Automatic Firmware Update• Device Configuration Setting
--	--

- Download the **SENA MOTORCYCLES App** on **Google Play Store** or **App Store**.

3.2 Charging

Charging the Bluetooth System

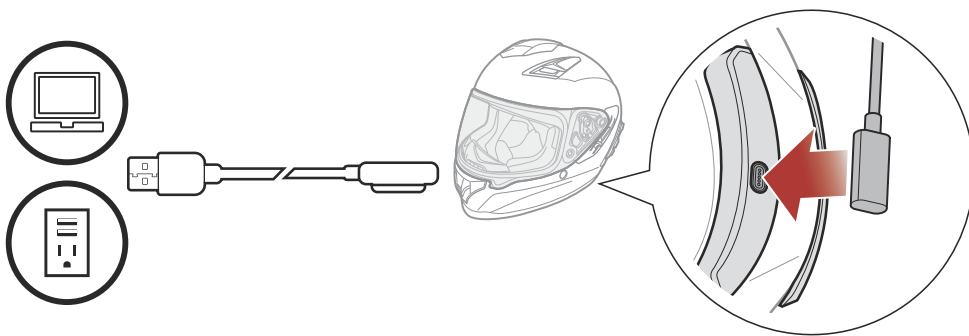

Depending upon the charging method, the Bluetooth system will be fully charged in about 2.5 hours.

Note:

- Please make sure to take off your helmet while charging. The Bluetooth system automatically turns off during charging.
- Any 3rd party USB charger can be used with Sena products if the charger is approved by either the FCC, CE, or IC.
- The **Bluetooth system** is compatible with 5 V input USB-charged devices only.

3.3 Legend

 Tap button the specified number of times

 Press and Hold button for the specified amount of time



"Hello"

Audible prompt

3.4 Powering On and Off

Powering On

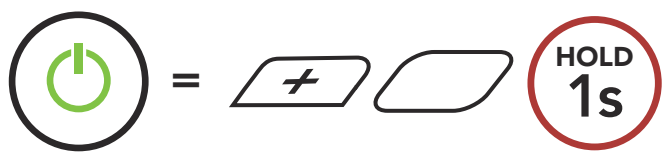

Powering Off

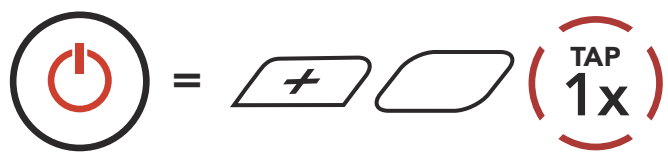

3.5 Checking the Battery Level

Instructions are for when powering the Bluetooth system on.

Powering On

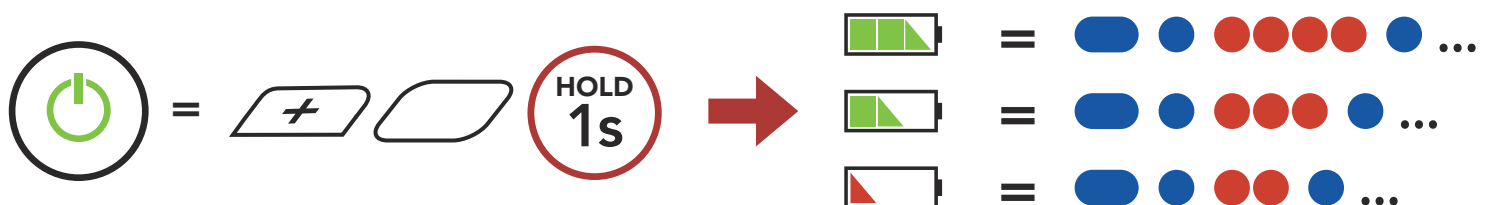

Note: When the battery is low while in use, you will hear a voice prompt saying "Low battery".

3.6 Volume Adjustment

You can raise or lower the volume by tapping the **(+) Button** or the **(-) Button**. Volume is set and maintained independently at different levels for each audio source (i.e., phone, intercom), even when the Bluetooth system is rebooted.

Volume Up

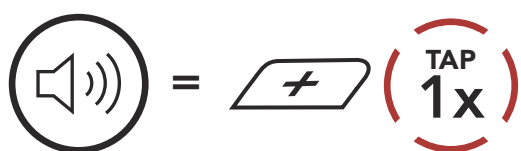

Volume Down

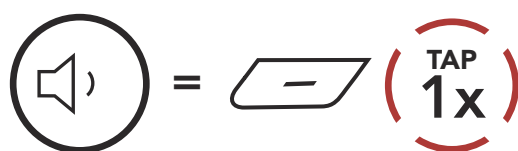

4. PAIRING THE BLUETOOTH SYSTEM WITH OTHER BLUETOOTH DEVICES

When using the Bluetooth system with other Bluetooth devices for the first time, they will need to be “paired.” This enables them to recognize and communicate with one another whenever they are within range.

The Bluetooth system can pair with multiple Bluetooth devices such as a mobile phone, GPS, MP3 player or Sena SR10 Two-Way Radio Adapter via **Mobile Phone Pairing, Second Mobile Phone Pairing and GPS Pairing**. The Bluetooth system can also be paired with up to three other Sena Bluetooth systems.

Pairs with up to Three Sena Bluetooth Systems



Also Pairs with:

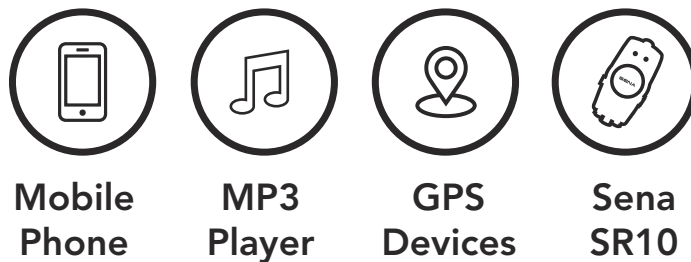

4.1 Phone Pairing

There are three ways to pair the phone.

4.1.1 Initially Pairing the Stryker

The Bluetooth system will automatically enter the phone pairing mode when you initially turn on the Bluetooth system or in the following situation:

- Rebooting after executing **Factory Reset**; or
- Rebooting after executing **Delete All Pairings**.

1. Press and hold the **Center Button** and the **(+) Button** for **1 second**.



2. Select **Stryker** in the list of Bluetooth devices detected. If your mobile phone asks for a PIN, enter 0000.



Note:

- The phone pairing mode lasts for **3 minutes**.
- To cancel phone pairing, tap the **Center Button**.

4.1.2 Pairing When the Stryker is Turned Off

1. While the Bluetooth system is off, press and hold the **Center Button** and the **(+) Button** until the LED flashes red and blue alternately and you hear a voice prompt, **"Phone pairing"**.



2. Select **Stryker** in the list of Bluetooth devices detected. If your mobile phone asks for a PIN, enter 0000.



4.1.3 Pairing When the Stryker is Turned On

1. While the Bluetooth system is on, press and hold the **Center Button** for **10 seconds**.

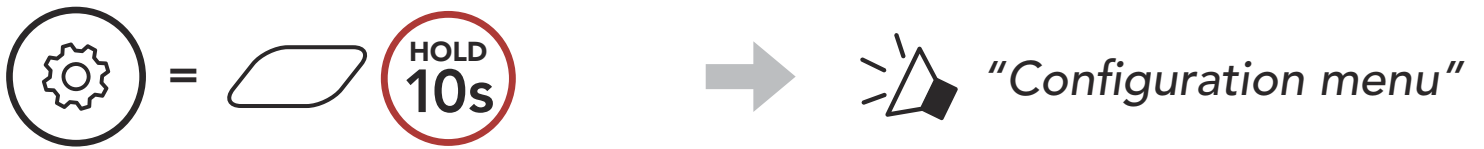

2. Tap the **(+) Button**.



3. Select **Stryker** in the list of Bluetooth devices detected. If your mobile phone asks for a PIN, enter 0000.

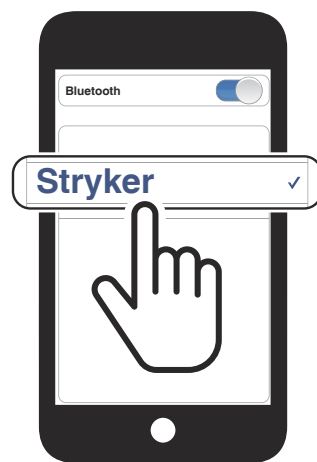

4.2 Second Mobile Phone Pairing - Second Mobile Phone, GPS, and SR10

1. Press and hold the **Center Button** for **10 seconds**.



2. Double tap the **(+) Button**.

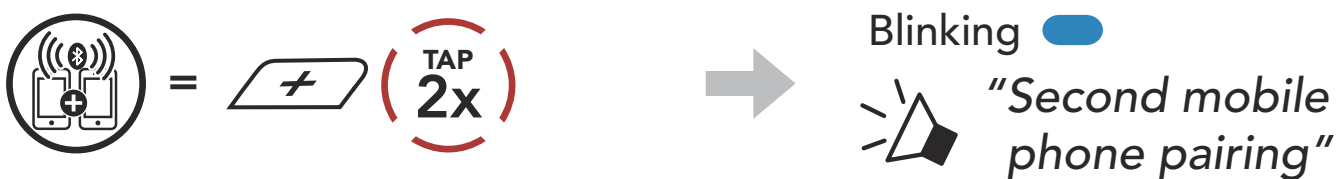

3. Select **Stryker** in the list of Bluetooth devices detected. If your mobile phone asks for a PIN, enter 0000.

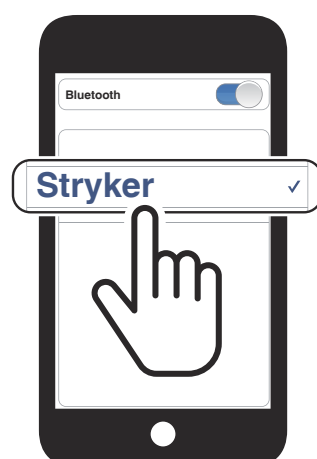

4.3 Advanced Selective Pairing: Hands-Free or A2DP Stereo

Phone Pairing allows the Bluetooth system to establish two Bluetooth profiles: **Hands-Free** or **A2DP Stereo**. **Advanced Selective Pairing** allows the Bluetooth system to separate the profiles to enable connection with two devices.

4.3.1 Phone Selective Pairing - Hands-Free Profile

1. Press and hold the **Center Button** for **10 seconds**.



2. Tap the **(+) Button 3 times**.

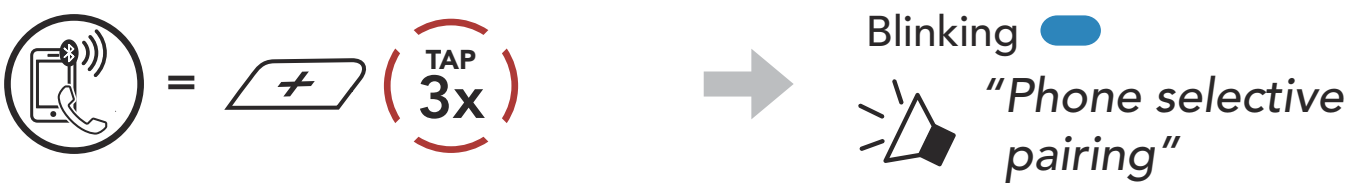

3. Select **Stryker** in the list of Bluetooth devices detected. If your mobile phone asks for a PIN, enter 0000.

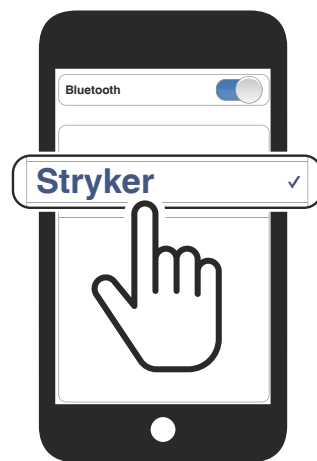

4.3.2 Media Selective Pairing - A2DP Profile

1. Press and hold the **Center Button** for **10 seconds**.

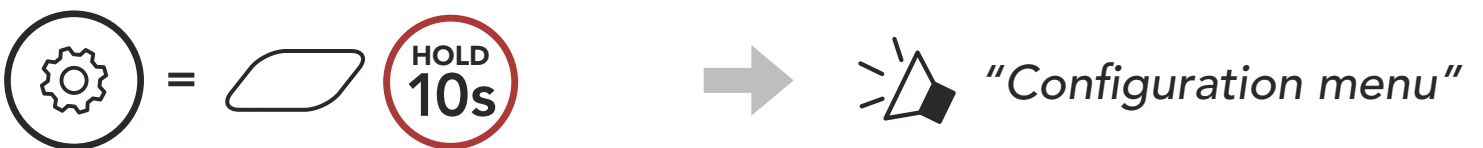

2. Tap the **(+) Button 4 times**.

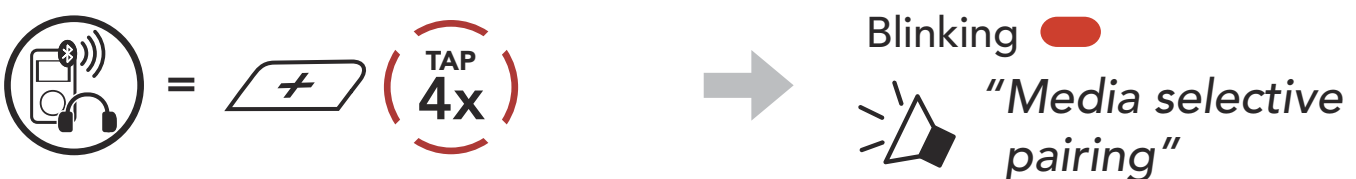

3. Select **Stryker** in the list of Bluetooth devices detected. If your mobile phone asks for a PIN, enter 0000.

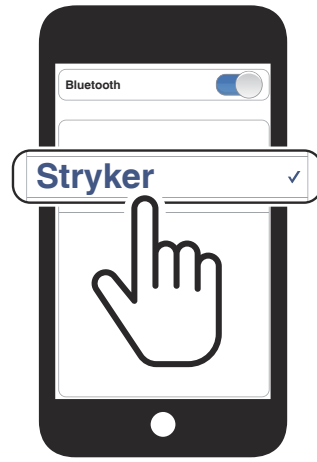

4.4 GPS Pairing

1. Press and hold the **Center Button** for **10 seconds**.

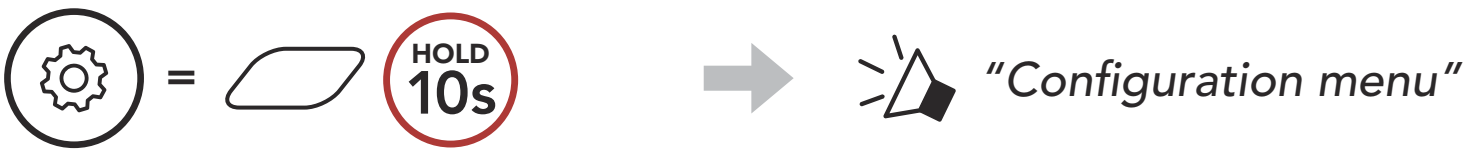

2. Tap the **(+) Button** **5 times**.



3. Select **Stryker** in the list of devices detected. If your Bluetooth device asks for a PIN, enter 0000.



Note: If you pair your GPS device via GPS Pairing, its instruction will not interrupt your Mesh Intercom conversations, but overlay with them. Bluetooth intercom conversations will be interrupted by GPS instructions.

5. MOBILE PHONE USAGE

5.1 Making and Answering Calls

Answer a Call

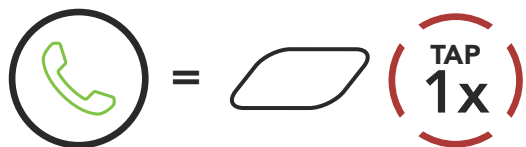

End a Call

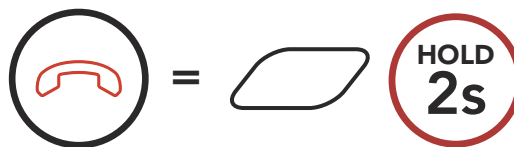

Reject a Call

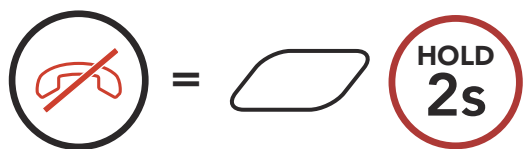

Note: If you have a GPS device connected, you will not hear its voice navigations during a phone call.

5.2 Siri and Google Assistant

The **Stryker** supports the **Siri** and **Google Assistant** access directly.

You can activate the **Siri** or **Google Assistant** using the voice through the Stryker's microphone, a wake word will be used. This is a word or groups of words such as "**Hey Siri**" or "**Hey Google**".

Activate the Siri or Google Assistant Installed on Your Smartphone



5.3 Speed Dialing

5.3.1 Assigning Speed Dial Presets

Speed Dial Presets could be assigned through the **SENA MOTORCYCLES App**.

5.3.2 Using Speed Dial Presets

1. Enter into the **Speed Dial** menu.

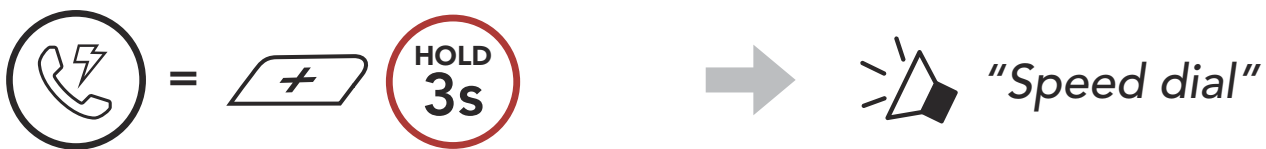

2. Navigate forward or backward through **Speed Dial Preset** numbers.

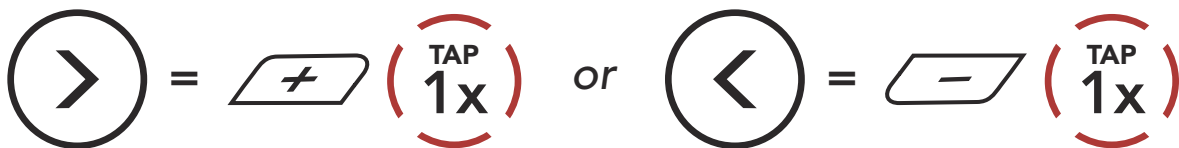

(1) Last number redial

(4) Speed dial 3

(2) Speed dial 1

(5) Cancel

(3) Speed dial 2

3. Call one of your **Speed Dial Presets** numbers.



4. Redial the last number called.

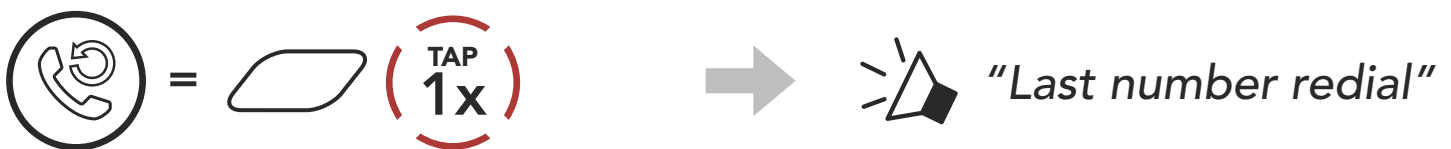

6. STEREO MUSIC

6.1 Bluetooth Stereo Music

Play/Pause Music

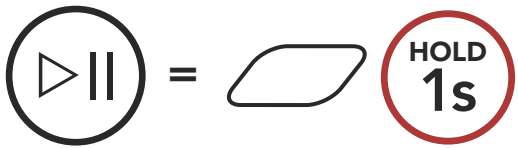

Next Track

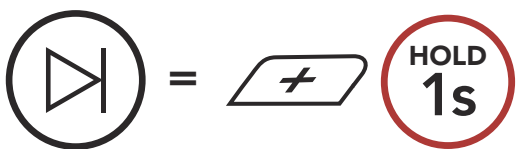

Previous Track

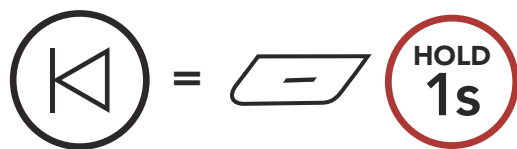

6.2 Music Sharing

You can start sharing music with one intercom friend using Bluetooth stereo music during a two-way intercom conversation and one participant of a Mesh. If you start sharing music while Bluetooth intercom and Mesh Intercom are running at the same time, then music shared during Bluetooth intercom will take priority over music shared during Mesh Intercom.

Note:

- Both you and your intercom friend can remotely control music playback such as track forward and track back.
- **Music sharing** will be paused when you are using your mobile phone or listening to GPS instructions.
- **Music sharing** will be terminated if the Bluetooth system starts a multi-way intercom conference.

6.2.1 Bluetooth Intercom Music Sharing

You can start sharing the music with one intercom friend of a two-way intercom conversation.

Start/Terminate Sharing Music



6.2.2 Mesh Intercom Music Sharing

You can start sharing music with one participant of a **Mesh Intercom**.

1. The **Creator** will send a request message to **participants** connected during **Mesh Intercom**.

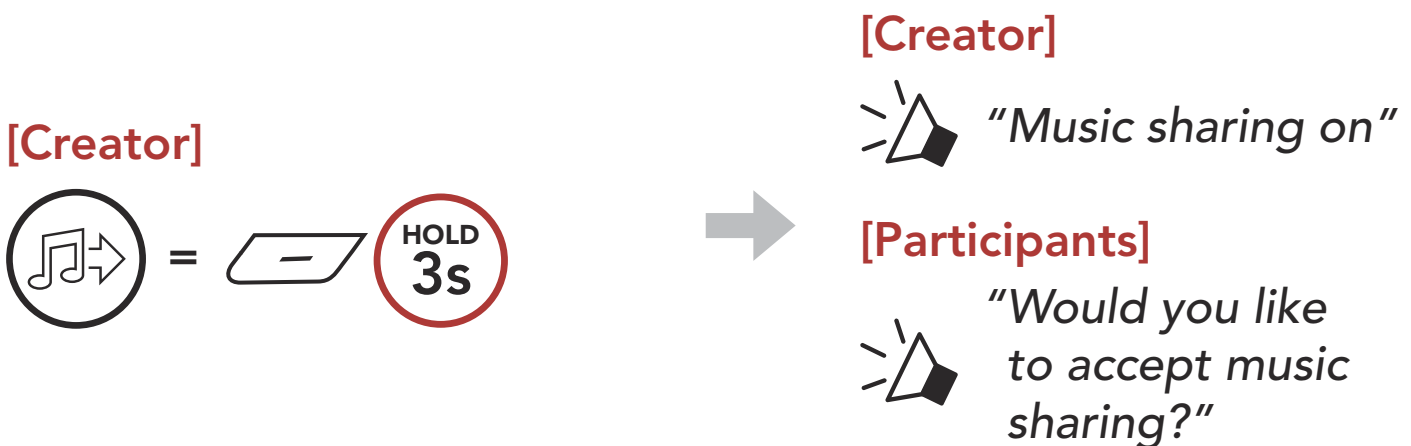

2. The **Creator** will share music with the **first participant** that accepts the request.

[Participant] Accept

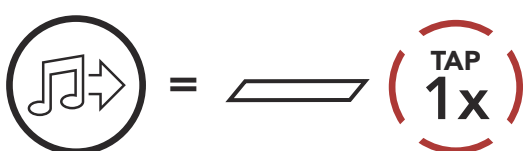

[Participant] Refuse

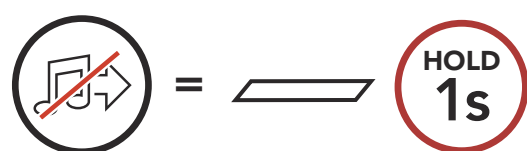

7. MESH INTERCOM

7.1 What is Mesh Intercom?

Mesh Intercom™ is a dynamic communication system created by Sena that provides instant and effortless bike-to-bike communication without a pre-grouping process. **Mesh Intercom** allows riders to connect and communicate with nearby users without the need to pair each Bluetooth system together.

The working distance between each **Stryker** in **Mesh Intercom** can be up to 2 km (1.2 miles) in open terrain. In open terrain, the **Mesh** can be extended up to 8 km (5 miles) between a minimum of six users. Within the same channel in **Open Mesh™** or the same private group in **Group Mesh™**, six users can talk at the same time and enjoy the optimal quality for their conversation.

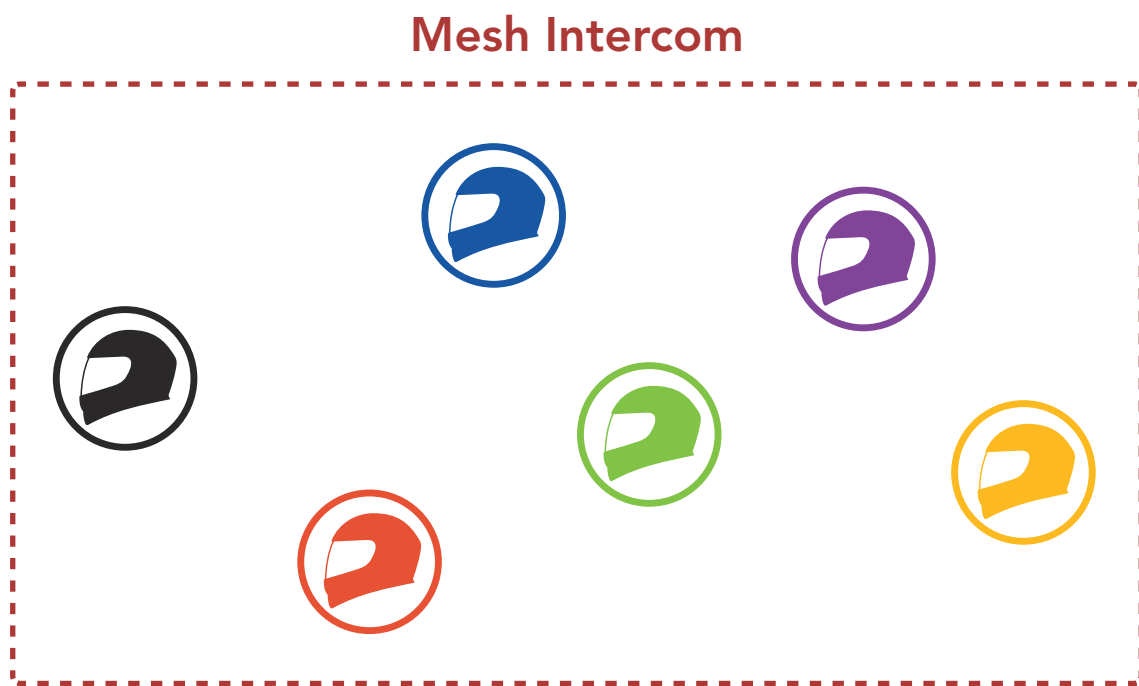

7.1.1 Open Mesh

Open Mesh is an open group intercom function. Users can freely communicate with each other in the same **Open Mesh** channel and select which channel (1-9) to use through the Bluetooth system.

It can connect with a virtually unlimited number of users in each channel.

Open Mesh

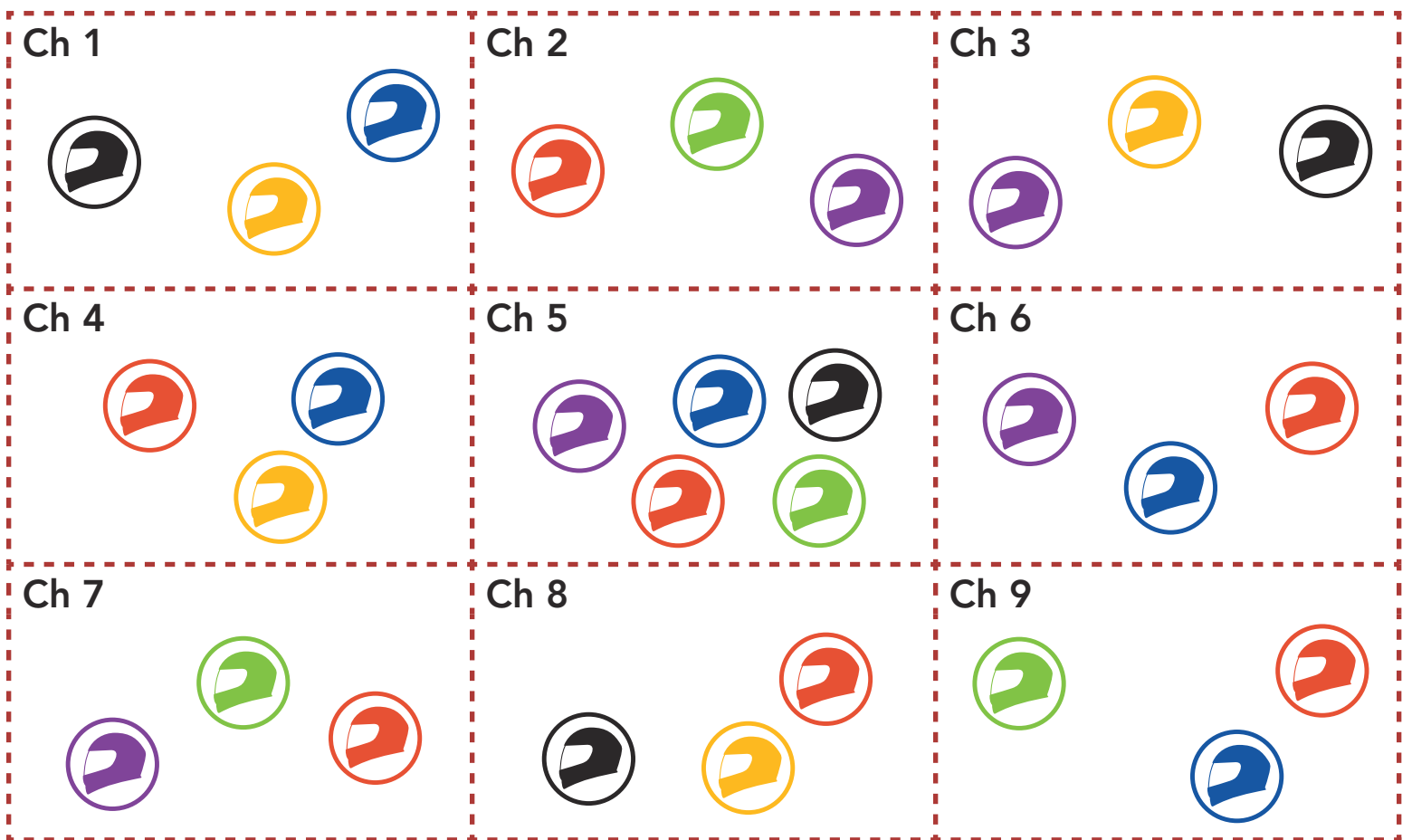

7.1.2 Group Mesh

Group Mesh is a closed group intercom function that allows users to join, leave, or rejoin a group intercom conversation without pairing each Bluetooth system. Users can freely communicate with each other in the same private group in **Group Mesh**.

For closed intercom conversations using **Mesh Intercom**, a **Group Mesh** needs to be created by the users. When users create a private group in **Group Mesh** by **Mesh Grouping**, the Bluetooth system automatically switches from **Open Mesh** to **Group Mesh**. Up to 24 users can all be connected in each private group.

Group Mesh



7.2 Starting Mesh Intercom

When **Mesh Intercom** is enabled, the **Stryker** will automatically connect to nearby **Stryker** users and allow them to talk to each other by pressing the **Mesh Intercom Button**.

Mesh Intercom On

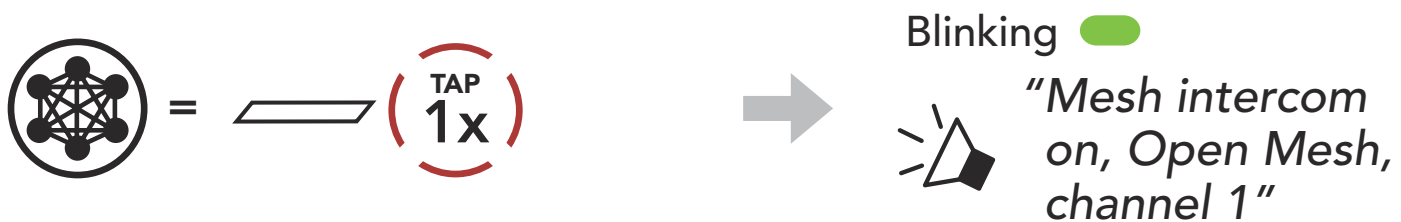

Mesh Intercom Off

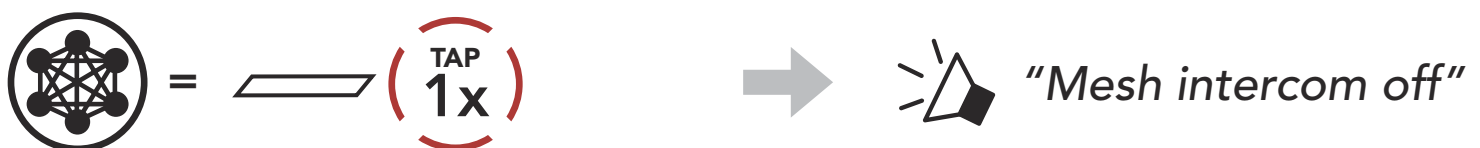

7.3 Using the Mesh in Open Mesh

When **Mesh Intercom** is enabled, the Bluetooth system will be in **Open Mesh (default: channel 1)** initially.

7.3.1 Channel Setting (Default: channel 1)

If the **Open Mesh** communication experiences interference because other groups are also using **channel 1 (default)**, change the channel. You can select from channels 1 to 9.

1. Double tap the **Mesh Intercom Button**.

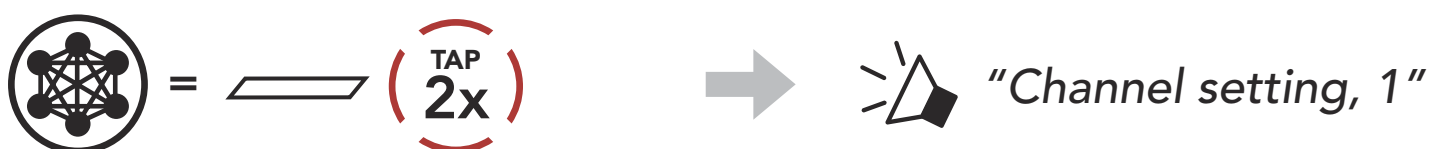

2. Navigate between channels.
(1 → 2 → ... → 8 → 9 → Exit → 1 → ...)



3. Save the channel.



Note:

- **Channel Setting** always starts with channel 1.
- If you do not press any button for approximately **10 seconds** in a specific channel, the channel is automatically saved.
- The channel will be remembered even if you turn off the **Stryker**.
- You can use the **SENA MOTORCYCLES App** to change the channel.

7.4 Using Mesh in Group Mesh

7.4.1 Creating a Group Mesh

Creating a **Group Mesh** requires **two or more Open Mesh users**.

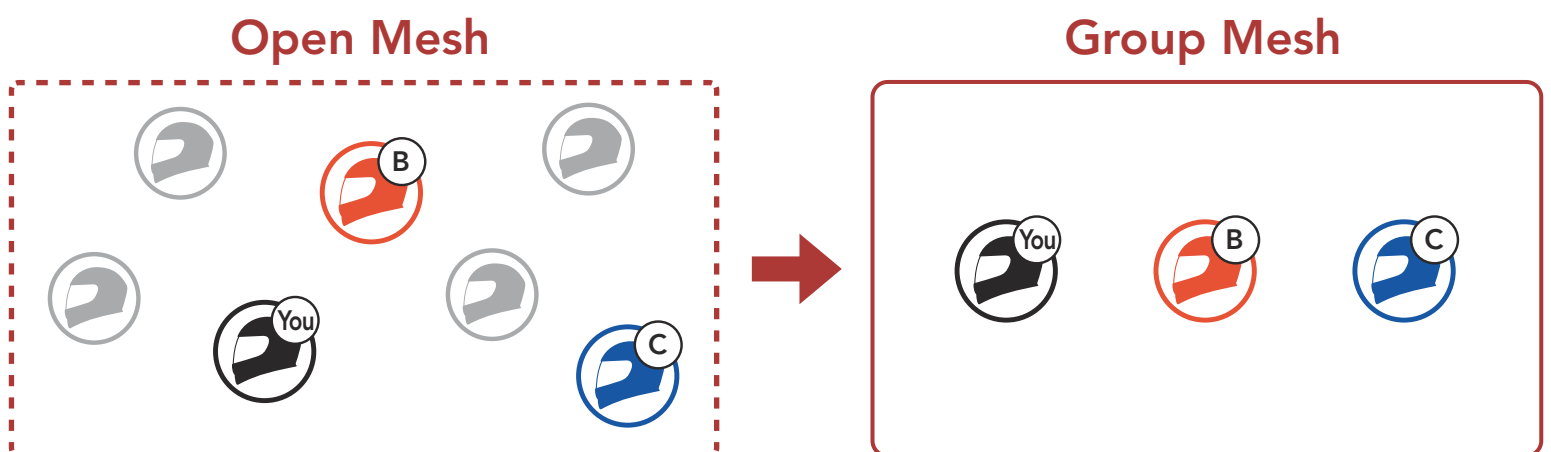

1. To enter **Mesh Grouping** to create a **Group Mesh**, press and hold the **Mesh Intercom Button** for **5 seconds** on the Bluetooth system of the **users (You, B, and C)**.



2. When **Mesh Grouping** is completed, the **users (You, B and C)** will hear a voice prompt on their Bluetooth system as **Open Mesh** switches to **Group Mesh**.



Note:

- If the **Mesh Grouping** is not completed within **30 seconds**, users will hear a voice prompt, **"Grouping failed"**.
- If you want to cancel during the **Mesh Grouping**, tap the **Mesh Intercom Button**.

7.4.2 Joining an Existing Group Mesh

One of the **current users** in an **Existing Group Mesh** can allow **new users (one or more)** in **Open Mesh** to join the **Existing Group Mesh**.

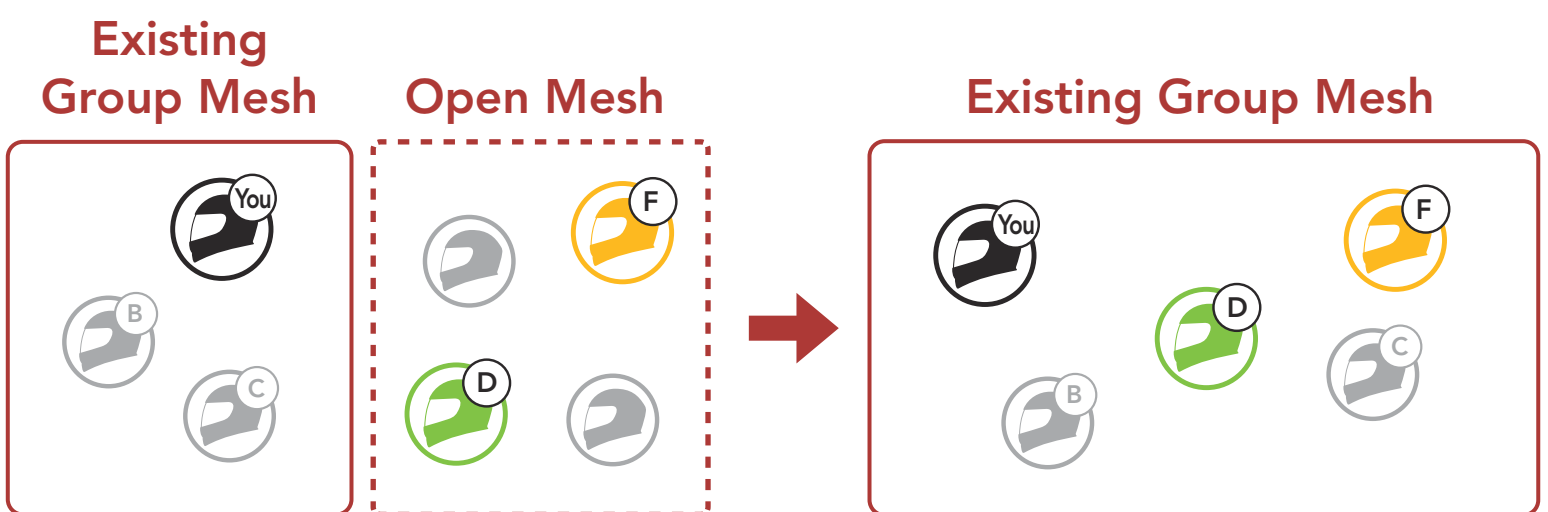

1. To enter **Mesh Grouping** to join the **Existing Group Mesh**, press and hold the **Mesh Intercom Button** for **5 seconds** on the Bluetooth systems of **one (You) of the current users** in the **Existing Group Mesh** and the **new users (D and F)** in **Open Mesh**.



2. When **Mesh Grouping** is completed, the **new users (D and F)** will hear a voice prompt on their Bluetooth system as **Open Mesh** switches to **Group Mesh**.



Note: If the **Mesh Grouping** is not completed within **30 seconds**, the current user (You) will hear a low tone double beep and the new users (D and F) will hear a voice prompt, **"Grouping failed"**.

7.5 Enable/Disable Mic (Default: Enable)

Users can enable/disable the microphone when communicating in a **Mesh Intercom**.

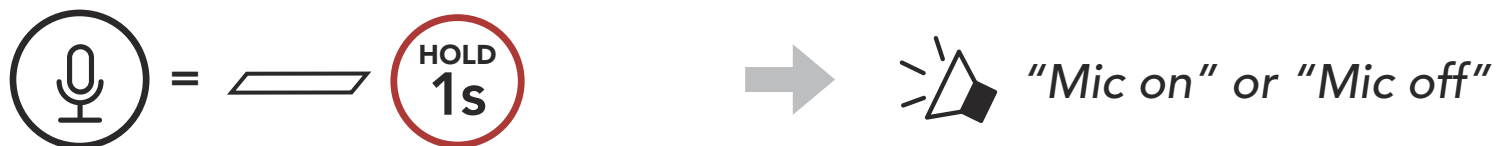

7.6 Toggling Open Mesh/Group Mesh

Users are able to toggle between **Open Mesh** and **Group Mesh** without resetting the **Mesh**. This allows users to keep the **Group Mesh Network** connection information while in **Open Mesh**.

Users can toggle to **Group Mesh** to communicate with participants from the stored **Group Mesh Network** connection information.

Toggle Between Open Mesh and Group Mesh

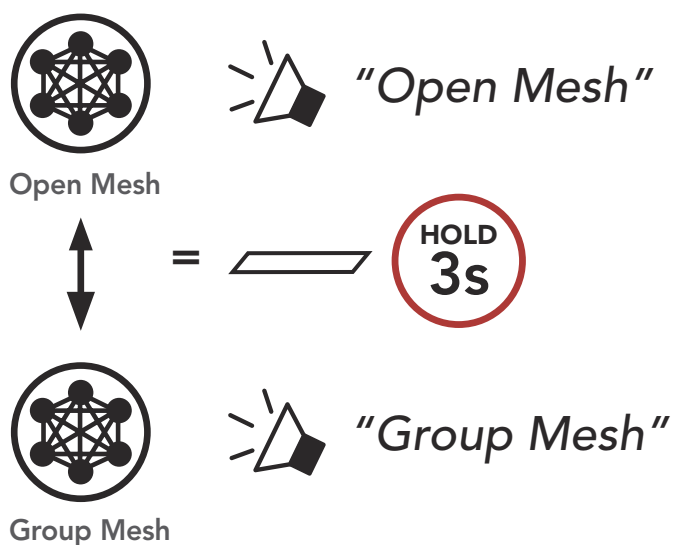

Note: If you have never participated in **Group Mesh**, you cannot toggle between **Open Mesh** and **Group Mesh**. You will hear a voice prompt, "No Group Available".

7.7 Reset Mesh

If a Bluetooth system in an **Open Mesh** or **Group Mesh** resets the **Mesh**, it will automatically return to **Open Mesh (default: channel 1)**.



8. BLUETOOTH INTERCOM

Up to three other people can be paired with the Bluetooth system for Bluetooth intercom conversations.

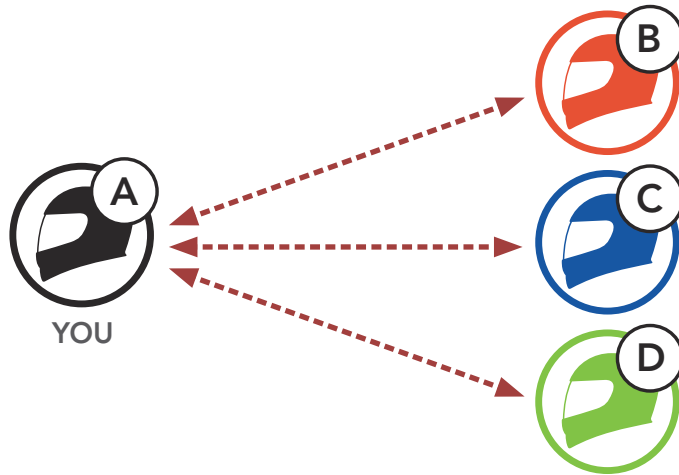



8.1 Intercom Pairing

There are two ways to pair the Bluetooth system.

8.1.1 Using the Smart Intercom Pairing (SIP)

SIP allows you to quickly pair with your friends for intercom communication by scanning the QR code on the **SENA MOTORCYCLES App** without remembering the button operation.

1. Pair the mobile phone with the Bluetooth system.
2. Open the **SENA MOTORCYCLES App** and tap  (**Smart Intercom Pairing Menu**).
3. Scan the **QR code** displayed on your friend (**B**)'s mobile phone.
 - Your friend (**B**) can display the QR code on the mobile phone by tapping  > **QR code** () on the **SENA MOTORCYCLES App**.



4. Tap **Save** and check that your friend **(B)** is paired with **you (A)** correctly.
5. Tap **Scan** (📷) and repeat steps 3-4 to pair with **Intercom Friends (C)** and **(D)**.

Note: The **Smart Intercom Pairing (SIP)** is not compatible with Sena products that use **Bluetooth 3.0** or **below**.

8.1.2 Using the Button



1. **Users (You, B)** enter into **Intercom Pairing**.



Blinking 



2. The **two Bluetooth systems (A and B)** will be automatically paired.



Turns blue 



3. Repeat the steps above to pair with **other Bluetooth systems (C and D)**.

8.2 Last-Come, First-Served

The intercom pairing queue is **Last-Come, First-Served**. If a Bluetooth system has multiple paired Bluetooth systems for intercom conversations, the last paired Bluetooth system is set as the **First Intercom Friend**. For example, after the pairing procedures listed above, **Bluetooth system (D)** is the **First Intercom Friend** of Bluetooth system (A). **Bluetooth system (C)** is the **Second Intercom Friend** of Bluetooth system (A), and **Bluetooth system (B)** is the **Third Intercom Friend** of Bluetooth system (A).

Intercom Pairing Order

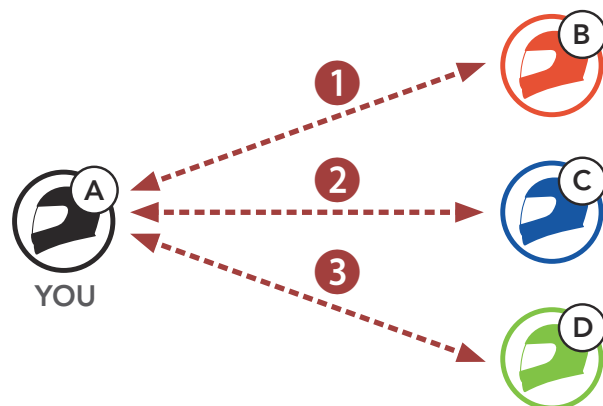
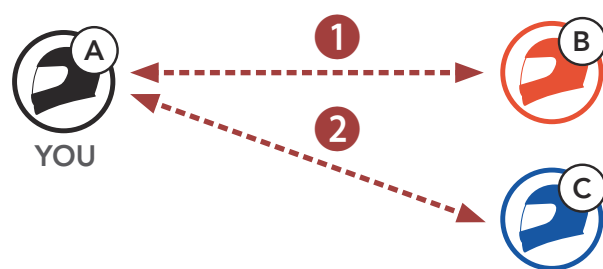

Last-Come, First-Served



8.3 Two-Way Intercom

You can start or end an intercom conversation with an **Intercom Friend**.



Start/End Conversation with the First Intercom Friend D

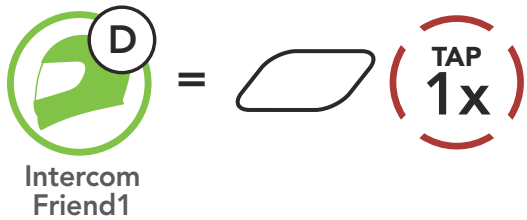

Start/End Conversation with the Second Intercom Friend C

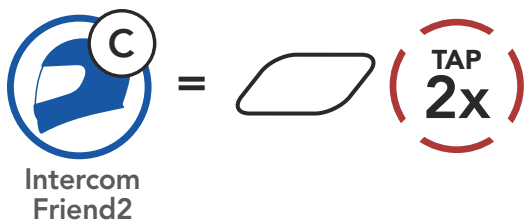

Start/End Conversation with the Third Intercom Friend B

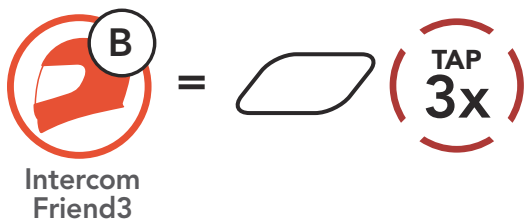

8.4 Multi-Way Intercom

Multi-Way Intercom enables conference-call-style conversations with up to **three Intercom Friends** at the same time. While **Multi-Way Intercom** is in progress, the mobile phone connection is temporarily disconnected. However, as soon as **Multi-Way Intercom** terminates, the mobile phone connection will be reestablished.

8.4.1 Starting a Three-Way Intercom Conference

You (A) can have a **Three-Way Intercom Conference** with two other **Intercom Friends (B and C)** by establishing two intercom connections simultaneously.

- You (A)** need to be paired with two other **Intercom Friends (B and C)** for the **Three-Way Intercom Conference**.



- Start an intercom conversation with the **First Intercom Friend (C)** by tapping the **Center Button**.



- You (A)** can call the **Second Intercom Friend (B)** by double tapping the **Center Button**, or the **Second Intercom Friend (B)** may join the intercom by making an intercom call to **you (A)**.



- Now **you (A)** and **two Intercom Friends (B and C)** are having a **Three-Way Intercom Conference**.



8.4.2 Starting a Four-Way Intercom Conference

With **three Intercom Friends** connected, a new participant (**D**) can make it a **Four-Way Intercom Conference** by making an intercom call to either (**B**) or (**C**).

1. **Intercom friend (B)** needs to be paired with a **new participant (D)**.



2. **Intercom friend (B)** can call a **new participant (D)** by tapping the **Center Button**, or a **new participant (D)** may join the intercom by making an intercom call to **Intercom friend (B)**.



3. Now **you (A)**, **two Intercom Friends (B and C)**, and a **new participant (D)** are having a **Four-Way Intercom Conference**.

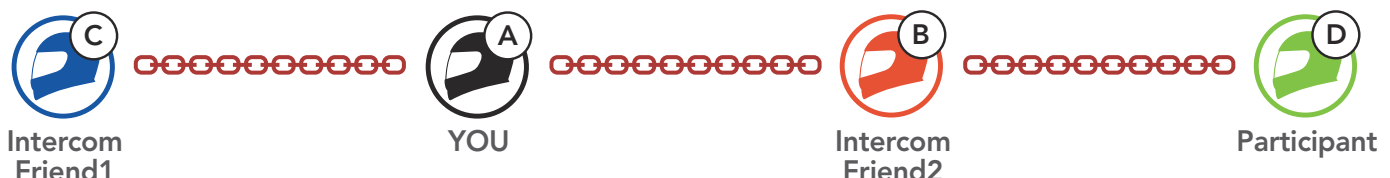

8.4.3 Ending Multi-Way Intercom

You can completely terminate the conference intercom or just disconnect an intercom connection with one of your active **Intercom Friends**.

Terminate All Intercom Connections

- Press and hold the **Center Button** for **3 second**.

Disconnect the Intercom Connection with One of the Intercom Friends

- Disconnect (C): Tap the **Center Button**.
- Disconnect (B) & (D): Double tap the **Center Button**.

Note: When you disconnect the **second friend (B)**, you will be disconnected with the **third participant (D)** as well. This is because the **third participant (D)** is connected with you via the **second friend (B)**.

8.5 Three-Way Conference Phone Call with Intercom Users

You can have a **Three-Way Conference Phone Call** by adding an **Intercom Friend** to the mobile phone conversation.

1. During a mobile phone call, tap the **Center Button once, twice, or three times** to invite one of your **Intercom Friends** to the conversation.

Invite an Intercom Friend into Phone Conference

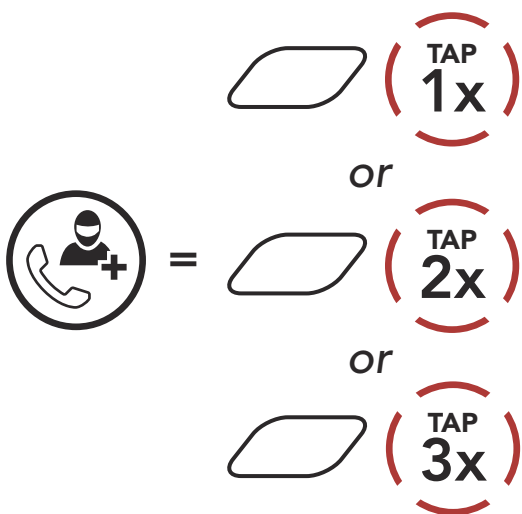

2. To disconnect the intercom during a conference phone call, tap the **Center Button once, twice, or three times**.

Disconnect the Intercom Friend from Conference

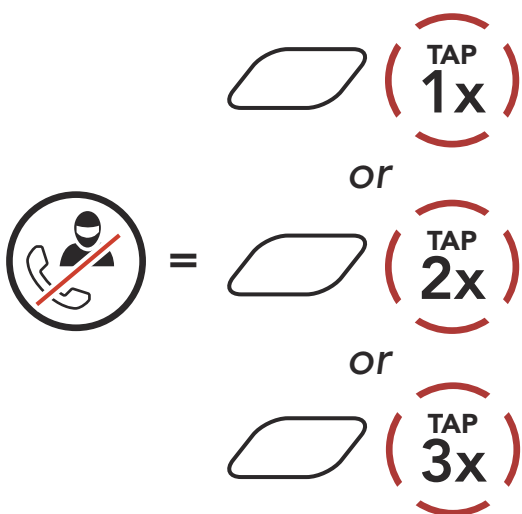

3. To disconnect the mobile phone call during a conference phone call, press and hold the **Center Button** for **2 seconds**.

End Phone Call from Conference

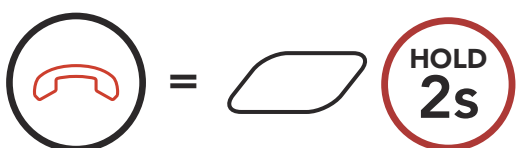

Note: When you have an incoming intercom call during a mobile phone call, you will hear high tone double beeps.

8.6 Group Intercom

Group Intercom allows you to instantly create a **Multi-Way Conference Intercom** with three of the most recently paired Bluetooth systems.

To Start the Group Intercom

1. Go through intercom pairing with up to three Bluetooth systems you want to have **Group Intercom** with.

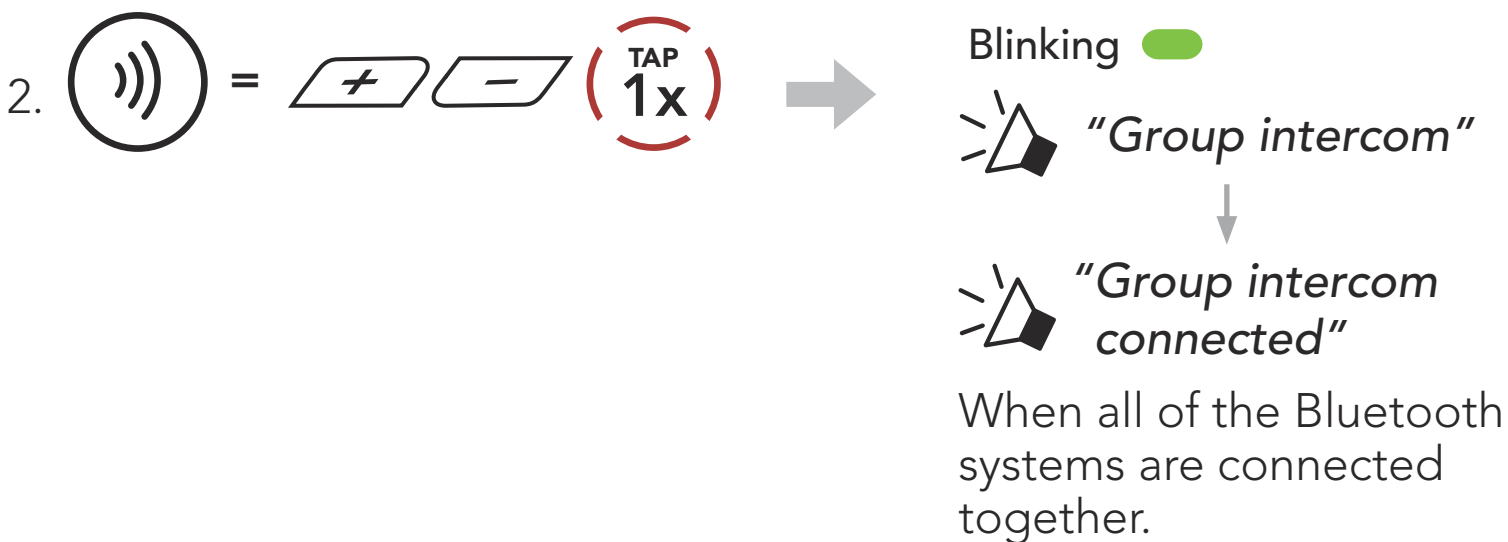

Terminate Group Intercom



8.7 Mesh Intercom Conference with Bluetooth Intercom Participant

Users can use the existing Bluetooth intercom and **Mesh Intercom** function at the same time. In this case, it is recommended to communicate with other Sena Bluetooth systems via Bluetooth intercom connection and use **Mesh Intercom** between Bluetooth systems. A user who is in **Open Mesh** or **Group Mesh** when using Mesh Intercom is able to include up to 3 of their Bluetooth intercom friends. You can start a Two-Way Intercom conversation with one of your three Intercom Friends to include them in the Mesh.

Note:

- The audio quality will be reduced if a **Stryker** connects to 2 or more Bluetooth intercom friends while in **Open Mesh** or **Group Mesh** when using **Mesh Intercom**.
- If a closed loop is created, as shown below, each user will experience severe noise issues. Sena recommends that a closed loop not be created.

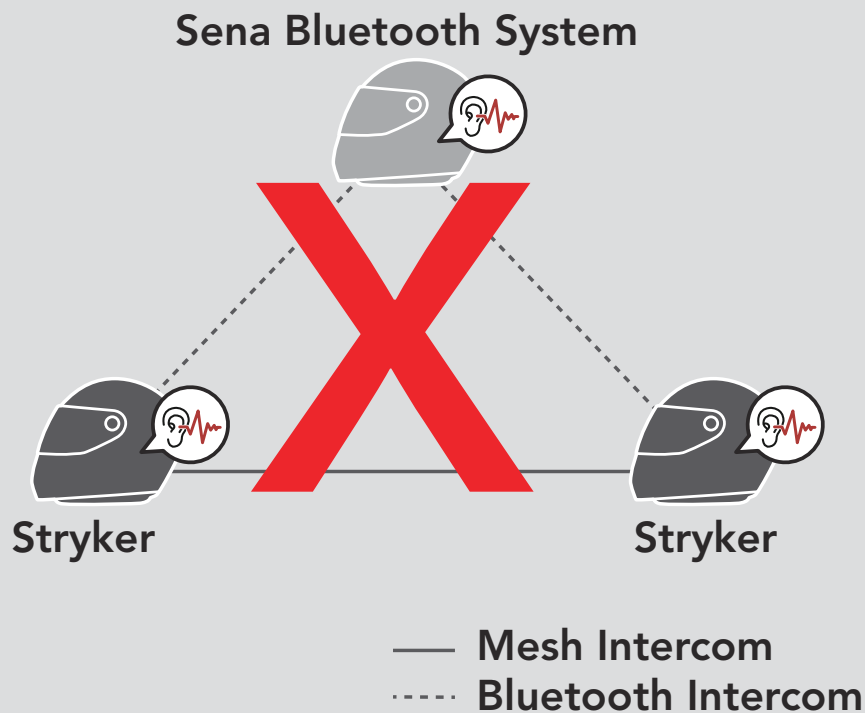



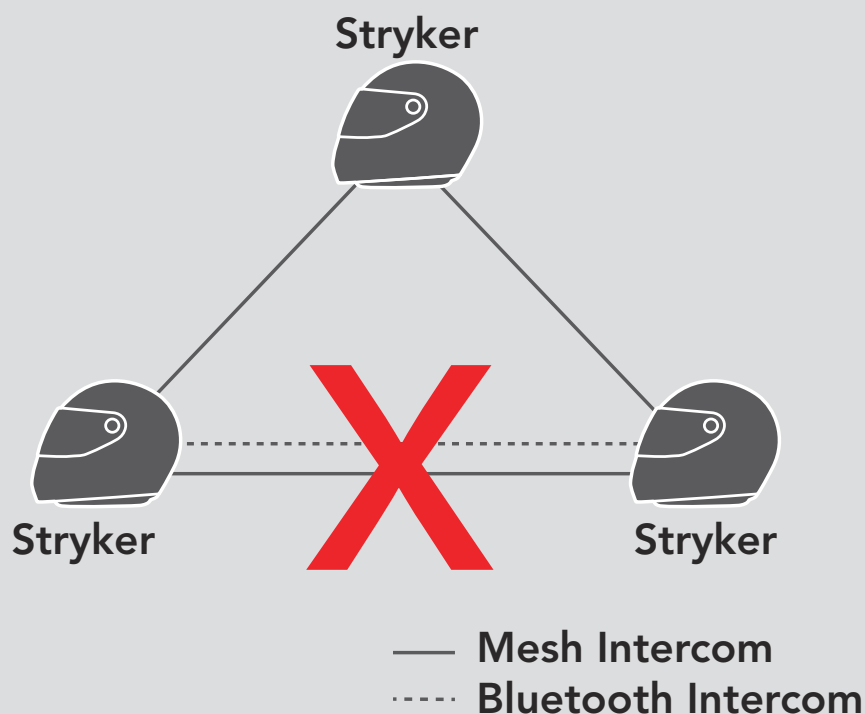







- If **Bluetooth intercom** is accidentally turned on during **Mesh Intercom** communication between **Stryker** Bluetooth systems, as shown below, you will hear a voice prompt, **"Mesh intercom disabled. Bluetooth intercom connected"** every **1 minute**. If you turn off the **Bluetooth Intercom** or turn off the **Mesh Intercom**, the voice prompt will no longer come out.



9. UNIVERSAL INTERCOM

Universal Intercom allows you to have intercom conversations with users of non-Sena Bluetooth headsets. Non-Sena Bluetooth headset can be connected to the Sena Bluetooth system if they support the **Bluetooth Hands-Free Profile (HFP)**. You can pair the Bluetooth system with only one non-Sena headset at a time. The intercom distance depends on the performance of the Bluetooth headset to which it's connected. When a non-Sena Bluetooth headset is paired with the Bluetooth system while another Bluetooth device is paired via **Second Mobile Phone Pairing**, it will be disconnected.

9.1 Universal Intercom Pairing

1.  =   →  "Configuration menu"
2.  =   →  "Universal intercom pairing"
3.  =   → Enter into **Universal Intercom Pairing** mode.

4. Put the non-Sena Bluetooth headset in Hands-free Pairing Mode. The Bluetooth system will automatically pair with a non-Sena Bluetooth headset.

9.2 Two-Way Universal Intercom

You can initiate the **Universal Intercom** connection with non-Sena Bluetooth headsets using the same intercom connection method as you would between other Sena headsets.

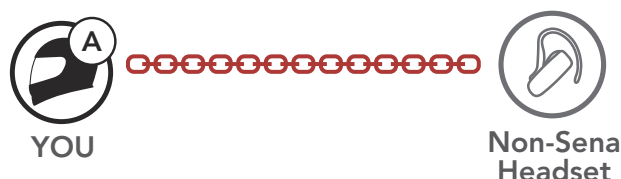

You may start/end a **Two-Way Universal Intercom** using the same way as you do in a normal **Two-Way Intercom**. Please refer to **Section 8.3: "Two-Way Intercom"**.

9.3 Multi-Way Universal Intercom

You can have **Multi-Way Intercom** communication with up to **three Intercom Friends** using non-Sena headsets. Some non-Sena headsets may not support **Multi-Way Universal Intercom**.

You may make the **Multi-Way Universal Intercom** call the same way as a normal four-way intercom call.

You may start/end a **Multi-Way Universal Intercom** using the same way as you do in a normal **Multi-Way Intercom**. Please refer to **Section 8.4: "Multi-Way Intercom"**.

9.3.1 Three-Way Universal Intercom

You may make a **Three-Way Universal Intercom** connection with two Bluetooth systems and one non-Sena Bluetooth headset. If the intercom connection is made, all headsets connected cannot use the mobile phone call function since the connection between the Bluetooth system and the phone is disconnected temporarily. If you disconnect the intercom call, the mobile phone connection is made again automatically so that you can use a mobile phone call function.

1. **You (A)** need to be paired with a non-Sena Bluetooth headset (**B**) and another headset (**C**) for the **Three-Way Conference Intercom**.

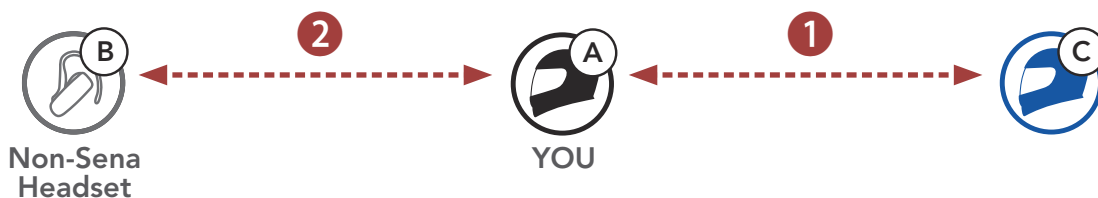

2. Start an intercom conversation with a non-Sena Bluetooth headset (**B**) in your intercom group. For example, **you (A)** may start an intercom conversation with non-Sena Bluetooth headset (**B**). The non-Sena Bluetooth headset (**B**) may also start an intercom call with **you (A)**.



3. The other Bluetooth system (**C**) may join the intercom by making an intercom call to **you (A)**.



4. Now **you (A)**, non-Sena Bluetooth headset (**B**), and the other Bluetooth system (**C**) are having a **Three-Way Conference Intercom**.



9.3.2 Four-Way Universal Intercom

You may make the **Four-Way Universal Intercom** call the same way as a normal **Four-Way Intercom** call.

You may make a **Four-Way Universal Intercom** connection with a couple of different configurations,

- 1) two Bluetooth systems and two non-Sena Bluetooth headsets or
- 2) three Bluetooth systems and one non-Sena Bluetooth headset.

Four-Way Universal Intercom Case 1

1) **You (A)**, a non-Sena Bluetooth headset (**B**), another Bluetooth system (**C**), and a non-Sena Bluetooth headset (**D**).

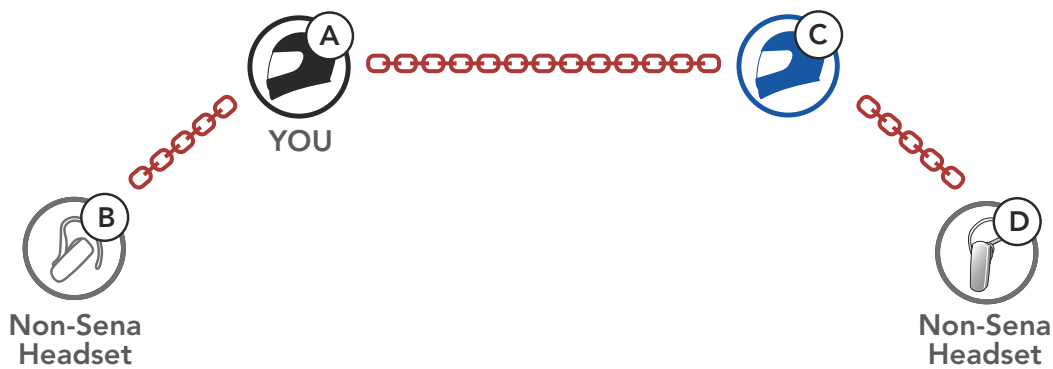

Four-Way Universal Intercom Case 2

2) **You (A)**, a non-Sena Bluetooth headset (**B**), and **two other Bluetooth systems (C and D)**.



9.4 Mesh Intercom Conference with Two-way Universal Intercom Participant

Users can use the existing **Two-way Universal Intercom** and **Mesh Intercom** function at the same time. In this case, it is recommended to communicate with **non-Sena headset** via **Two-way Universal Intercom** connection and use **Mesh Intercom** between **Bluetooth systems**.

A user who is in **Open Mesh** or **Group Mesh** when using **Mesh Intercom** is able to include one **Universal Intercom friend**. You can start a **Two-way Universal Intercom** conversation with your **Universal Intercom Friend** to include it in the **Mesh**.

10. USING THE FM RADIO

10.1 FM Radio On/Off

FM Radio On



FM Radio Off



10.2 Seek and Save Radio Stations

The **"Seek"** feature searches for radio stations.

1. Search for radio stations.

Seek Stations Forward

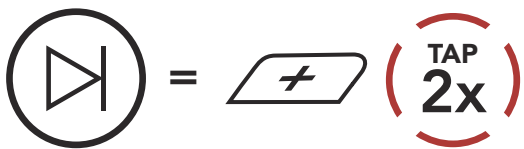

Seek Stations Backward

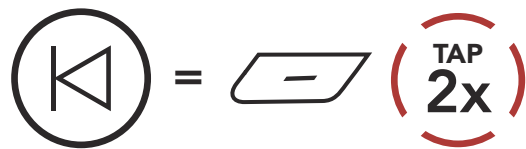

2. Save the current station.

Enter Preset Selection Mode



3. Navigate through the preset numbers that you want to store.

Navigate Forward/Backward Through Preset Stations

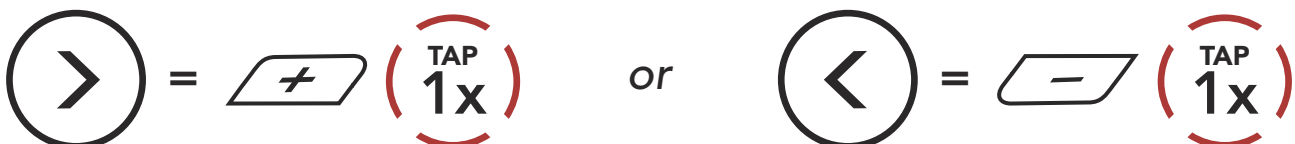

4. Save the station in the preset number you choose or delete the station from memory.

Save Station to the Preset Number

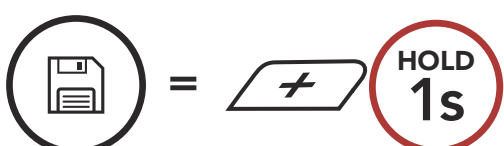

Delete Station from Memory

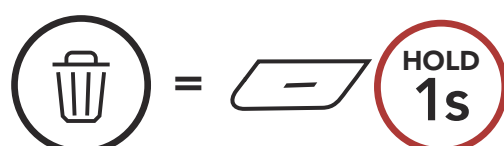

10.3 Scan and Save Radio Stations

The **“Scan”** function automatically searches for radio stations, starting with the current station’s frequency, then up from there.

1. Scan for stations.

Start Scanning

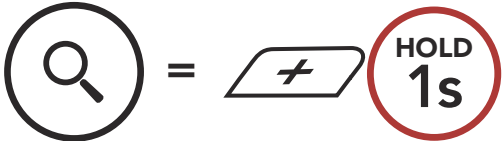

Stop Scanning

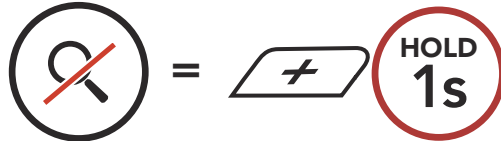

2. The Sena tuner pauses at each station it finds for **8 seconds** before moving to the next.
3. Save the current station. The station will be saved as the next preset number.

Save the Current Station



Note: You can use the **SENA MOTORCYCLES App** to save the preset stations.

10.4 Temporary Station Preset

The **Temporary Preset** feature automatically finds and saves the nearest 10 radio stations without changing your existing preset stations.

1. Automatically find and save 10 stations.

Temporary Stations

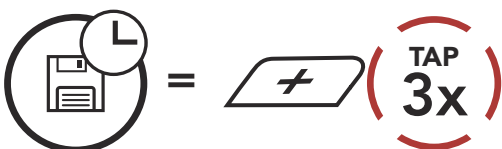

2. The temporary preset stations will be cleared when the Bluetooth system reboots.

10.5 Navigating Preset Stations

Using the methods above, up to 10 radio stations can be stored. You can navigate through the saved stations.

Navigate through Preset Stations

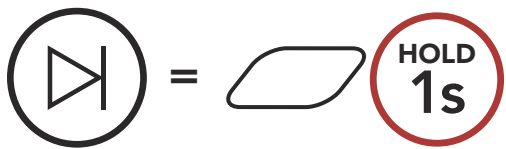

11. LED TAILLIGHT

You can control the LED Taillight through the **SENA MOTORCYCLES App**.

- **Mode** : Solid / Night Flash / Day Flash / Off

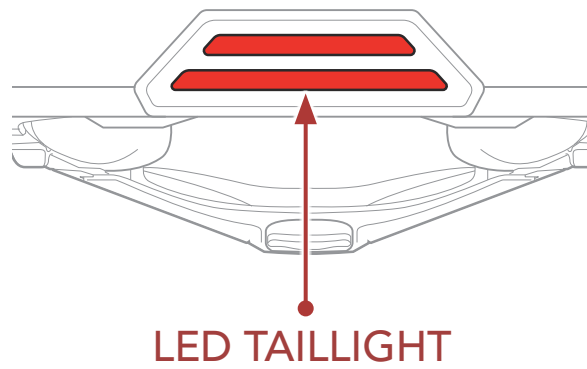

12. VOICE COMMAND

The **Voice Command** of the Bluetooth system allows you to operate certain operations by simply using your voice. You can control the Bluetooth system completely handsfree using the voice recognition. Multi-language Voice Command supports **English, French, German, Spanish, Italian, Chinese, Japanese, and Russian.**

Speak a Voice Command List

Mode Status	Function	Voice Command
Standby/ Bluetooth Intercom/Mesh Intercom/FM Radio/Music	Check battery	"Hey Sena, Check Battery"
	Volume Up	"Hey Sena, Volume Up"
	Volume Down	"Hey Sena, Volume Down"
	Phone Pairing	"Hey Sena, Phone Pairing"
	Bluetooth Intercom Pairing	"Hey Sena, Pairing Intercom"
	Start/End each Bluetooth Intercom	"Hey Sena, Intercom [one, two, three]"
Standby/ Bluetooth Intercom/FM Radio/Music	Turn on Mesh Intercom	"Hey Sena, Mesh On"
Mesh Intercom	Turn off Mesh Intercom	"Hey Sena, Mesh Off"
	Mesh Grouping	"Hey Sena, Mesh Grouping"
	Switch to Open Mesh	"Hey Sena, Open Mesh"
	Switch to Group Mesh	"Hey Sena, Group Mesh"
	End the Bluetooth Intercom and Mesh Intercom	"Hey Sena, End Intercom"
Standby/ Bluetooth Intercom/Mesh Intercom	Play Music	"Hey Sena, Play Music"
Standby/ Intercom/Mesh Intercom/Music	Turn on FM radio	"Hey Sena, FM Radio On"

Mode Status	Function	Voice Command
Music/FM Radio	<ul style="list-style-type: none"> • FM - Next Preset • Music - Next Track 	"Hey Sena, Next"
	<ul style="list-style-type: none"> • FM - Previous Preset • Music - Previous Track 	"Hey Sena, Previous"
Music	Pause Music	"Hey Sena, Stop Music"
FM Radio	Turn off FM Radio	"Hey Sena, FM Radio Off"
Answer an Incoming Call		"Answer"
Ignore an Incoming Call		"Ignore"

Note:

- You can set a language to another language by using the **Headset Language** feature on the **SENA MOTORCYCLES App**.
- If you set a language that does not support voice commands, the voice command will work only with English commands.
- You can see the another language's voice command list on the **SENA MOTORCYCLES App**.
- **Voice command** performance may vary based on the environmental conditions.

13. FUNCTION PRIORITY

The Bluetooth system operates in the following order of priority:

- (highest)** Mobile phone
- Mesh Intercom/Bluetooth Intercom
- Music sharing via Bluetooth stereo
- FM radio

- (lowest)** Bluetooth stereo music

A lower-priority function gets interrupted by a higher-priority function. For example, stereo music will be interrupted by an **Intercom Conversation**; an **Intercom Conversation** will be interrupted by an incoming mobile phone call.

14. FIRMWARE UPGRADES

14.1 Wi-Fi-Enabled for Automatic Firmware Update

You can automatically install any available firmware updates to your Bluetooth system via a wireless network.

Built-in Wi-Fi in the Bluetooth System

- IEEE 802.11 b/g/n
- Working distance: Within 10 m

14.1.1 Connecting to the Bluetooth System

Firmware will be upgraded automatically when the **Bluetooth system** is charging. If you want to upgrade the firmware, you must first change the settings in the **SENA MOTORCYCLES App**.

1. Connect the helmet to the USB charger (5 V/1 A), the **Bluetooth system** will power off automatically.
2. The **built-in Wi-Fi** automatically turns on and the red LED flashes quickly.

Note:

- Any 3rd party USB charger (5 V/1 A) can be used for firmware updates if the charger is approved by either the FCC, CE, or IC.
- Do not connect the **Bluetooth system** to a USB port on your PC to update the firmware.
- Do not disconnect the **USB Cable** while updating the firmware. Doing so may damage the product.
- Do not turn the **Bluetooth system** on while updating the firmware. Doing so may damage the product.

14.1.2 Connection Setup





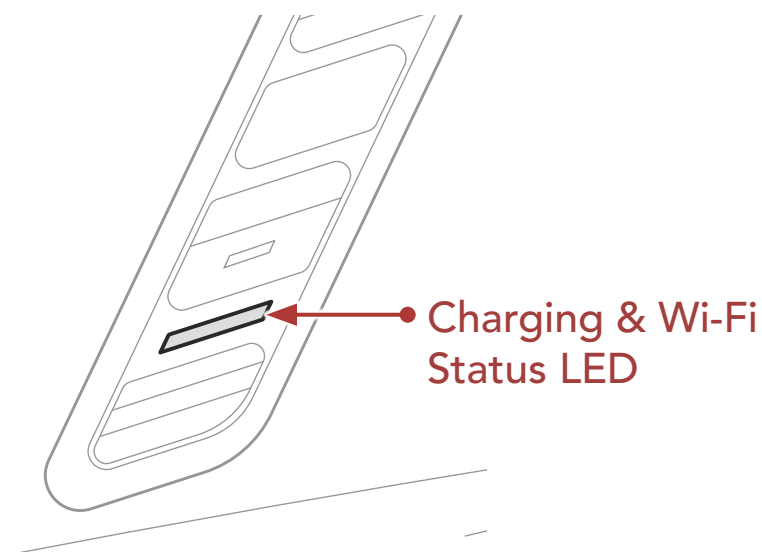

1. Open the **SENA MOTORCYCLES App**.
2. Tap the Menu button (⚙️) in the top-right corner of the screen and select **Update via WiFi**.
3. Follow the **instructions** on the **SENA MOTORCYCLES App** to connect the **built-in Wi-Fi** to a Wi-Fi access point.

Note: To change the Wi-Fi access point, execute **Wi-Fi Reset** then repeat the steps above.

14.1.3 LED Description

Charging & Wi-Fi Status LED



	Charging & disconnected from a Wi-Fi access point
 FAST BLINKING	Charging & searching for a Wi-Fi access point
 BLINKING	Charging & connected to a Wi-Fi access point
	Fully charged & disconnected from a Wi-Fi access point
 FAST BLINKING	Fully charged & searching for a Wi-Fi access point
 BLINKING	Fully charged & connected to a Wi-Fi access point

Firmware Upgrade Status LED

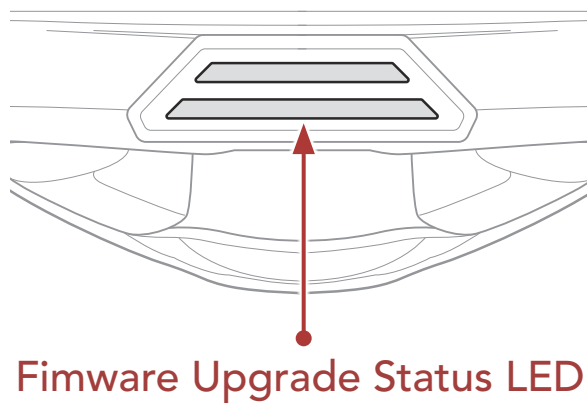

Upgrading Firmware

1 and 2 are repeated: 1 ↻ 2

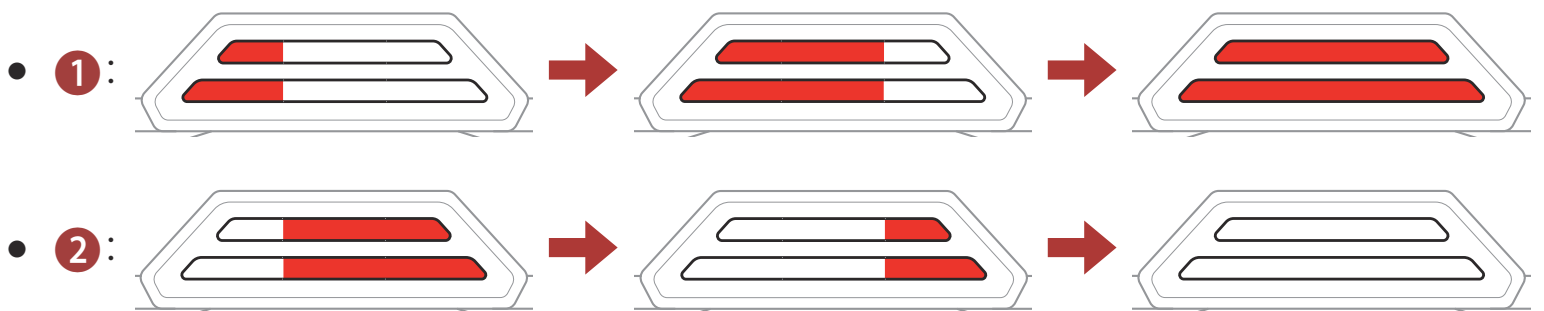

Firmware Upgrade Completed

1 and 2 are repeated: 1 ↻ 2

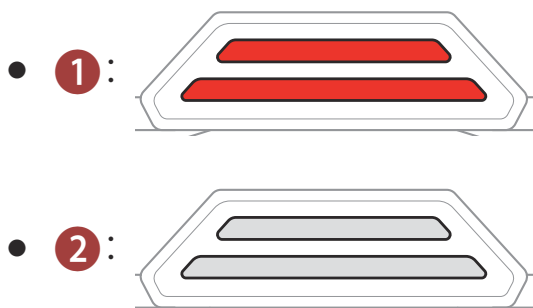

14.1.4 Wi-Fi Reset

The **built-in Wi-Fi** setting will be restored to the factory default settings, which include the **Wi-Fi configuration setup**, the **firmware setup**, and the **language setup**.



Note: Wi-Fi Reset is only possible when the Bluetooth system is being charged.

15. CONFIGURATION SETTING

15.1 Bluetooth System Configuration Menu

Accessing the Configuration Menu

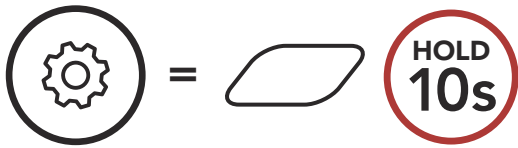

Navigating Between Menu Options

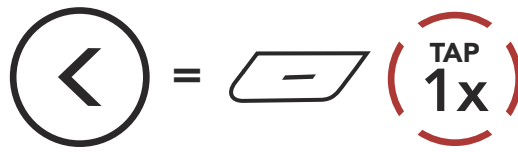
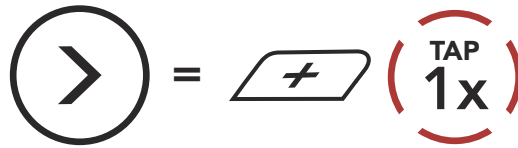

Execute Menu Options

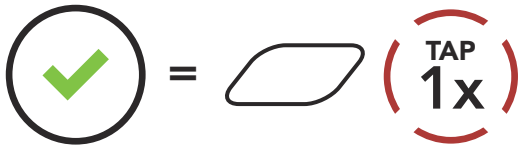

Bluetooth System Configuration Menu

Voice Configuration Menu	Tap the Center Button
Mobile Phone Pairing	None
Second Mobile Phone Pairing	None
Phone Selective Pairing	None
Media Selective Pairing	None
GPS Pairing	None
Delete All Pairings	Execute
Remote Control Pairing	Execute
Universal Intercom Pairing	Execute
Factory Reset	Execute
Exit Configuration	Execute

15.1.1 Delete All Pairings

You can delete all Bluetooth pairing information of the Bluetooth system.

15.1.2 Remote Control Pairing

You can remotely control the Bluetooth system using **Sena Remote Control devices** (sold separately).

1. Turn on the Bluetooth system and the Remote Control device.
2. Execute **Remote Control Pairing**.
3. Enter pairing mode in the Remote Control device. The Bluetooth system will automatically connect with the Remote Control device in pairing mode.

15.2 Software Configuration Setting

You can change the settings of the Bluetooth system through the **SENA MOTORCYCLES App**.



15.2.1 Headset Language

You can select the device language. The selected language is maintained even when the Bluetooth system is rebooted.

15.2.2 Audio Equalizer (Default: Music Balance)

Increase or decrease the decibel level of different frequency ranges of audio.

- **Music Balance** will adjust frequency response that gives the most natural balance between lows, mids, and highs.
- **Music Enhanced** will lower midrange frequencies slightly.
- **Voice** will increase midrange frequencies of the human voice and cut environmental noise for better clarity with voice communication.
- **Bass Boost** will increase the bass range of audio (130 Hz and below).
- **Treble Boost** will increase the high range of audio (6 kHz and above).

15.2.3 VOX Phone (Default: Enable)

If this feature is enabled, you can answer incoming calls by voice. When you hear a ringtone for an incoming call, you can answer the phone by saying a word such as **"Hello"** loudly or by blowing air into the microphone. **VOX Phone** is temporarily disabled if you are connected to intercom. If this feature is disabled, you have to tap the **Center Button** to answer an incoming call.

15.2.4 VOX Intercom (Default: Disable)

If this feature is enabled, you can initiate an intercom conversation with the last connected intercom friend by voice. When you want to start intercom, say a word such as **"Hello"** loudly or blow air into the microphone. If you start an intercom conversation by voice, the intercom terminates automatically when you and your intercom friend remain silent for 20 seconds. However, if you manually start an intercom conversation by tapping the **Center Button**, you have to terminate the intercom conversation manually. However, if you start the intercom by voice and end it manually by tapping the **Center Button**, you will not be able to start intercom by voice temporarily. In this case, you have to tap the **Center Button** to restart the intercom. This is to prevent repeated unintentional intercom connections by strong wind noise. After rebooting the Bluetooth system, you can start intercom by voice again.

15.2.5 VOX Sensitivity (Default: 3)

VOX Sensitivity can be adjusted depending on your riding environment. **Level 5** is the highest sensitivity setting and **level 1** is the lowest.

15.2.6 HD Intercom (Default: Enable)

HD Intercom enhances the two-way intercom audio from normal quality to HD quality. **HD Intercom** will become temporarily disabled when you enter into a multi-way intercom. If this feature is disabled, the two-way intercom audio will change to normal quality.

Note:

- The intercom distance of **HD Intercom** is relatively shorter than that of normal intercom.
- **HD Intercom** will become disabled temporarily when **Bluetooth Intercom Audio Multitasking** is enabled.

15.2.7 HD Voice (Default: Enable)

HD Voice allows you to communicate in high-definition during phone calls. This feature increases the quality so that the audio will be crisp and clear during phone call conversations. If this feature is enabled, incoming phone calls will interrupt intercom conversations and audio from the SR10 will not be heard during intercom conversations. **Three-Way Conference Phone Call with Intercom Participant** will not be available if **HD Voice** is enabled.

Note:

- Refer to the manufacturer of your Bluetooth device that will be connected to the Bluetooth system to see if it supports **HD Voice**.
- **HD Voice** is active only when **Bluetooth Intercom Audio Multitasking** is disabled.

15.2.8 Bluetooth Intercom Audio Multitasking (Default: Disabled)

Audio Multitasking (Bluetooth Intercom Audio Multitasking and Mesh Intercom Audio Multitasking) allows you to have an intercom conversation while simultaneously listening to music, FM radio, or GPS instructions. The overlaid audio is played in the background with reduced volume whenever there is an intercom conversation and will return to normal volume once the conversation is finished.

The **Mesh Intercom Audio Multitasking** feature is **always on**.

Note:

- For **Bluetooth Intercom Audio Multitasking** to work properly, you need to power the Bluetooth system off and on. **Please restart the Bluetooth system.**
- **Bluetooth Intercom Audio Multitasking** will be activated during two-way intercom conversations with a Bluetooth system that also supports this feature.
- Some GPS devices may not support this feature.
- The **Audio Multitasking** feature can be configured through the **Intercom-Audio Overlay Sensitivity** and the **Audio Overlay Volume Management settings**.

15.2.9 Intercom-Audio Overlay Sensitivity (Default: 3)

The music, FM radio and GPS volume will be lowered to play in the background if you talk over the intercom while the overlaid audio is playing. You can adjust the intercom sensitivity to activate this background audio mode. **Level 1** has the lowest sensitivity and **level 5** has the highest sensitivity.

Note: If your voice is not louder than the sensitivity of the selected level, the overlaid audio will not be lowered.

15.2.10 Audio Overlay Volume Management (Default: Disable)

The music, FM radio and GPS overlaid audio reduces in volume whenever there is an ongoing intercom conversation. If **Audio Overlay Volume Management** is enabled, the volume level of the overlaid audio will not be reduced during an intercom conversation.

15.2.11 Smart Volume Control (Default: Disable)

Enabling **Smart Volume Control** automatically changes the level of the speaker volume based on the level of the environment noise. You can enable it by setting the sensitivity to **low**, **medium** or **high**.

15.2.12 Sidetone (Default: Disable)

Sidetone is audible feedback of your own voice. It helps you to naturally speak at the correct level according to varying helmet noise conditions. If this feature is enabled, you can hear what you are speaking during an intercom conversation or a phone call.

15.2.13 Voice Prompt (Default: Enable)

You can disable **Voice Prompts** by software configuration settings, but the following voice prompts are always on.

- Bluetooth system configuration settings menu, battery level indicator, speed dial, FM radio functions

15.2.14 RDS AF Setting (Default: Disable)

Radio Data System (RDS) Alternative Frequency (AF) Setting allows a receiver to re-tune to the second frequency location when the first signal becomes too weak. With RDS AF enabled on the receiver, a radio station with more than one frequency can be used.

15.2.15 FM Station Guide (Default: Enable)

When **FM Station Guide** is enabled, FM station frequencies are given by voice prompts as you select preset stations. When **FM Station Guide** is disabled, the voice prompts on FM station frequencies will not be given as you select preset stations.

15.2.16 Advanced Noise Control™ (Default: Enable)

When **Advanced Noise Control** is enabled, the background noise is reduced during an intercom conversation. When it is disabled, the background noise is mixed with your voice during intercom.

15.2.17 Region Selection

You can select the proper FM frequency range for your location. Using the region setting, you can optimize the seek function to avoid unnecessary frequency ranges.

Region	Frequency range	Step
Worldwide	76.0 ~ 108.0 MHz	± 100 kHz
North America, South America and Australia	87.5 ~ 107.9 MHz	± 200 kHz
Asia and Europe	87.5 ~ 108.0 MHz	± 100 kHz
Japan	76.0 ~ 95.0 MHz	± 100 kHz

16. TROUBLESHOOTING

Please visit [sena.com](https://www.sena.com) for more troubleshooting information.

- Customer Support: [sena.com](https://www.sena.com)

16.1 Fault Reset

When the Bluetooth system is not working properly, you can easily reset the unit:

1. Locate the **Pinhole Fault Reset Button** above the **Magnetic DC Power Charging & Firmware Upgrade Port**.
2. Gently insert a paper clip into the hole and press and **Pinhole Fault Reset Button** with light pressure.

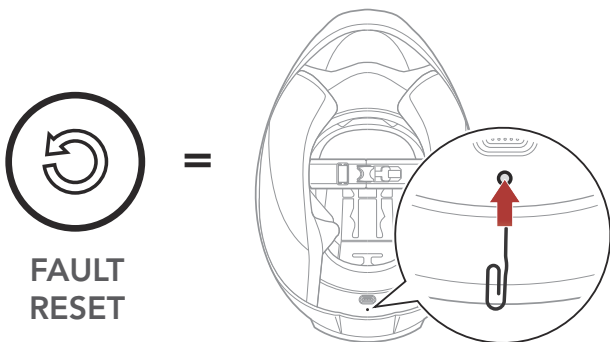

3. The Bluetooth system will shut down.

Note: Fault Reset will not restore the Bluetooth system to factory default settings.

16.2 Factory Reset

To erase all of your settings and start fresh, the Bluetooth system can be restored to factory default settings using the **Factory Reset** feature.

1. = → "Configuration menu"
2. = → "Factory reset"
3. = → "Headset reset, good-bye"

17. MAINTENANCE AND CARE

17.1 Outer Shell

Use a soft cloth and a small amount of water to remove bugs from the exterior.

Note: Never use gasoline, diesel fuel, thinners or solvents to clean the helmet. These substances can cause serious damage to the helmet, even though the resulting damage may not be visible. The full safety function of the helmet can then no longer be guaranteed.

17.2 Inner Lining

The inner lining of the helmet is completely removable. Its headliner can be washed by hand using mild soap at a maximum temperature of 30°C (86°F). Allow the lining to dry at room temperature.

17.3 Storing the Helmet

Store the helmet in a dry, dark, well-ventilated location, out of the reach of children and animals. Always position the helmet so that it cannot fall to the floor. Damage that occurs in this way is not covered by the warranty.



Copyright © 2022 Sena Technologies, Inc.
All rights reserved.

© 1998–2022 Sena Technologies, Inc. All rights reserved.

Sena Technologies, Inc. reserves the right to make any changes and improvements to its product without providing prior notice.

Sena™ is a trademark of Sena Technologies, Inc. or its subsidiaries in the USA and other countries. SF1™, SF2™, SF4™, SFR™, SRL™, Momentum™, Momentum INC™, Momentum Lite™, Momentum Pro™, Momentum INC Pro™, Momentum EVO™, Cavalry™, Latitude SR™, Latitude SX™, Latitude S1™, 30K™, 33i™, 50S™, 50R™, 50C™, 5S™, 20S EVO™, 20S™, 10S™, 10C™, 10C PRO™, ProRide EVO™, 10C EVO™, 10U™, 10Upad™, 10R™, ACS10™, C1™, 3S™, 3S PLUS™, SMH5™, SMH5-FM™, SMH5 MultiCom™, SMH10™, SMH10R™, SPH10™, SPH10H-FM™, Savage™, Prism Tube WiFi™, Prism™, Bluetooth Audio Pack for GoPro®, Impulse™, R1™, R1 EVO™, R1 EVO CS™, R2™, R2 EVO™, R2X™, M1™, M1 EVO™, RUMBA™, RC1™, RC3™, RC4™, Stryker™, Handlebar Remote™, Wristband Remote™, PowerPro Mount™, Powerbank™, FreeWire™, WiFi Docking Station™, WiFi Sync Cable™, WiFi Adapter™, +mesh™, +Mesh Universal™, MeshPort Blue™, MeshPort Red™, MeshPort Black™, Econo™, OUTRUSH™, OUTRUSH R™, OUTSTAR™, OUTSTAR S™, OUTFORCE™, OUTRIDE™, EcoCom™, Parani A10™, Parani A20™, Parani M10™, pi™, Snowtalk™, Snowtalk2™, SR10™, SR10i™, SM10™, SPIDER RT1™, SPIDER ST1™, X1™, X1 Pro™, X1S™, Expand™, Expand Boom™, Bluetooth Mic & Intercom™, Tufftalk™, Tufftalk Lite™, Tufftalk M™ are trademarks of Sena Technologies, Inc. or its subsidiaries. These trademarks may not be used without the express permission of Sena.

GoPro® is a registered trademark of Woodman Labs of San Mateo, California. Sena Technologies, Inc. ("Sena") is not affiliated with Woodman Labs, Inc. The Sena Bluetooth Pack for GoPro® is an aftermarket accessory specially designed and manufactured by Sena Technologies, Inc. for the GoPro® Hero3 and Hero4 allowing for Bluetooth capabilities.

The Bluetooth® word mark and logos are owned by the Bluetooth SIG, Inc. and any use of such marks by Sena is under license. iPhone® and iPod® touch are registered trademarks of Apple Inc.

Address: 152 Technology Drive Irvine, CA 92618