

Copyright © 2018 by Big Bike Parts, Inc. No part of this instruction sheet may be reproduced without the written permission of Big Bike Parts, Inc.

PART NO. 52-922A

AMBER LED MARKER LIGHT SET

FITMENT: HONDA GOLDWING/ GOLDWING TOUR 2018-NEWER

4/9/2019

**TOOLS NEEDED:**

PLIERS

8MM SOCKET

SOCKET WRENCH

WIRE CUTTER/CRIMPER

5MM ALLEN WRENCH

**PLEASE READ THROUGH AND UNDERSTAND THESE INSTRUCTIONS BEFORE BEGINNING.****ESTIMATED INSTALLATION TIME: 45 TO 60 MIN.****BIG BIKE PARTS RECOMMENDS INSTALLING AN ELECTRONIC FUSE BLOCK (PART NO. 52-942) BEFORE CONNECTING ANY ADDED ELECTRICAL ACCESSORIES TO THE BIKE.****INSTALLATION:**

1. USE A 5MM ALLEN WRENCH TO REMOVE THE 4 SCREWS (2 SCREWS EACH SIDE) MOUNTING THE FRONT FENDER. (FIG. 1) REMOVE THE FRONT FENDER BY SLIGHTLY PULLING OUT ON EACH SIDE OF THE FENDER AND LIFTING UP.
2. REMOVE THE LARGE RUBBER GROMMET FROM INSIDE OF THE LEFT FORK. (FIG. 2-VIEW FROM FRONT OF BIKE) GROMMET WILL BE REUSED. GROMMET ALSO SHOWN IN FIG. 6.
3. USING AN 8MM SOCKET, REMOVE THE NUT ON THE BACK OF THE LEFT REFLECTOR ACCESSED THROUGH THE GROMMET OPENING INSIDE OF THE FORK. (FIG. 3 SHOWS LOCATION OF NUT)
4. REMOVE THE REFLECTOR BY PULLING STRAIGHT OUT FROM THE FORK.
5. DETERMINE WHICH IS THE NEW LEFT AND RIGHT MARKER LIGHT. (FIG. 4) SET RIGHT MARKER LIGHT ASIDE.
6. FEED THE END OF THE WIRE CABLE FROM THE LEFT LIGHT THROUGH THE LARGE OPENING ON THE OUTSIDE OF THE FORK AS WELL AS THE RUBBER GROMMET OPENING. (FIG. 5) INSERT THE NEW LEFT LIGHT IN PLACE.
7. USE THE 8MM SOCKET TO SECURE THE LEFT LIGHT WITH THE FLAT WASHER AND NYLOCK HEX NUT SUPPLIED INSIDE THE FORK.
8. CUT A 9MM (3/8") WIDE NOTCH IN THE LEFT RUBBER GROMMET AS SHOWN IN FIG. 6. INSERT THE GROMMET INTO THE LEFT FORK WITH THE WIRE CABLE PASSING THROUGH THE NOTCH AT THE BOTTOM. (FIG. 7)
9. REPEAT STEPS 2 THROUGH 8 ON THE OPPOSITE (RIGHT) SIDE OF THE BIKE FOR THE RIGHT MARKER LIGHT. **NOTE: BE SURE TO CUT RIGHT GROMMET OPPOSITE OF FIG. 6.**
10. USING WIRE TIES TO SECURE THE WIRE CABLE, RUN WIRE CABLES ALONG THE BRAKE LINES BACK TO THE BIKES FRAME IN FRONT OF THE MOTOR. BE SURE TO LEAVE ENOUGH WIRE CABLE SLACK ALONG THE FORKS AND TO THE FRAME WHILE SECURING TO ALLOW FULL MOVEMENT OF SUSPENSION AND STEERING WITHOUT PULLING OR PINCHING THE WIRE CABLES.
11. CHECK THAT THE WIRE CABLES WILL NOT INTERFERE WITH THE BRAKES, STEERING, OR WHEEL MOVEMENT.
12. RUN WIRE CABLES ABOVE THE MOTOR (LEFT LIGHT WIRE CABLE WILL RUN ALONG LEFT SIDE OF MOTOR, RIGHT LIGHT WIRE CABLE WILL RUN ALONG RIGHT SIDE OF MOTOR) AND BACK BETWEEN THE FUEL TANK AND THE FRAME. WIRE CABLES SHOULD COME OUT UNDER THE SEAT ON EACH SIDE OF THE FUEL TANK.
13. CONNECT WIRES FROM NEW LIGHTS TO CORRESPONDING TERMINALS ON AN ELECTRONIC FUSE BLOCK (52-942 OR EQUIVALENT) USING FIG. 8.
14. SECURE REMAINING CABLE WITH REMAINING WIRE TIES.
15. TEST ALL FUNCTIONS OF THE LEFT AND RIGHT LIGHT.
16. REINSTALL FRONT FENDER WITH THE FOUR 5MM SCREWS YOU REMOVED IN STEP 1. (STEP 1 REVERSED)

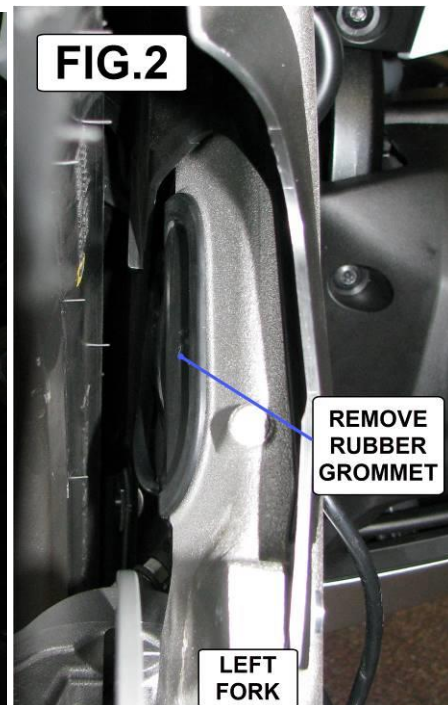
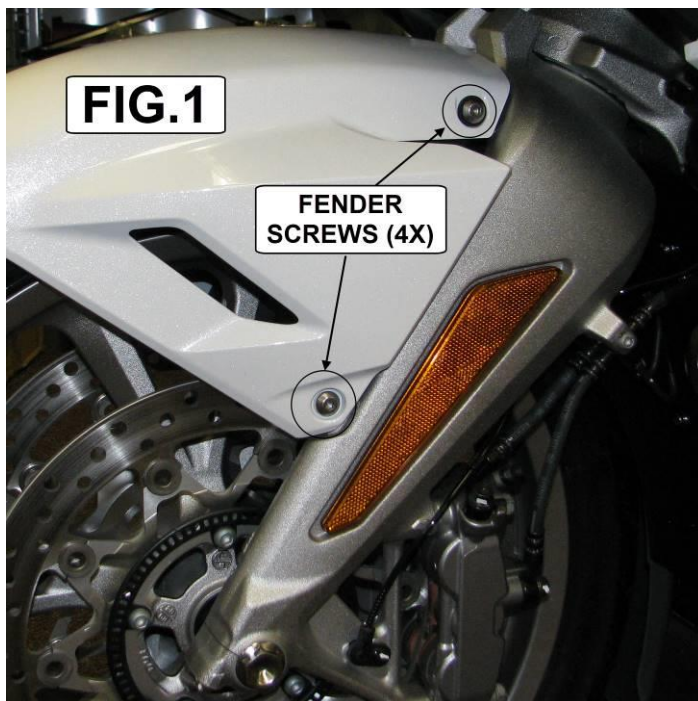

**NOTICE**

IGNORING THE CONTENTS OF THESE INSTRUCTIONS MAY AFFECT THE PRODUCT PERFORMANCE AND FUNCTIONALITY. NOT FOLLOWING THESE INSTRUCTION MAY CAUSE DAMAGE TO THE PRODUCT OR THE VEHICLE TO WHICH IT IS BEING ATTACHED.

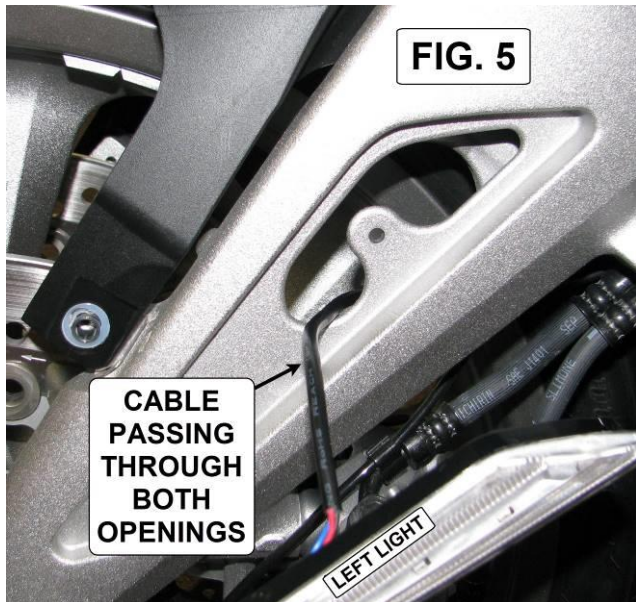
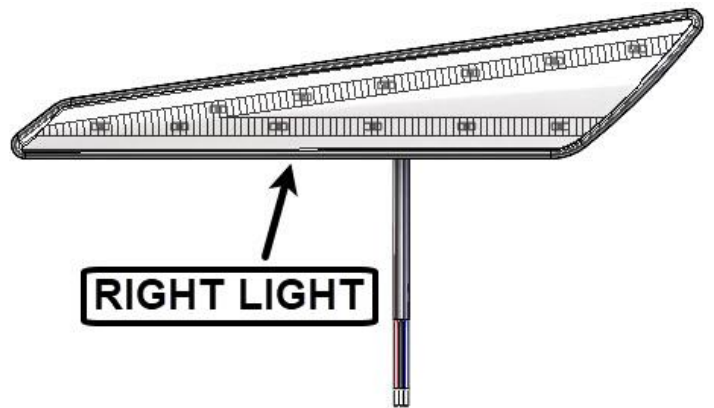
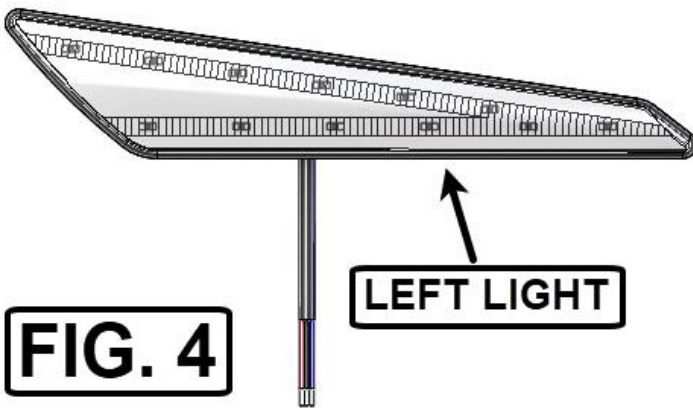
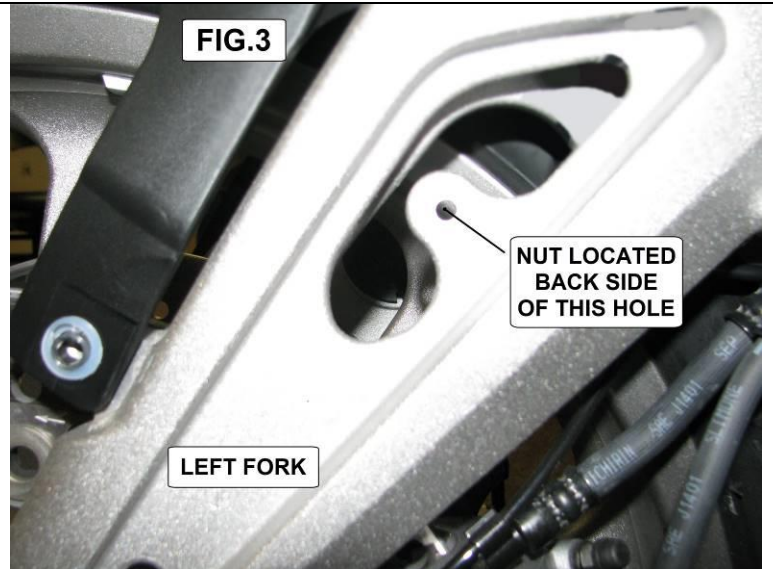

**FIG. 7**

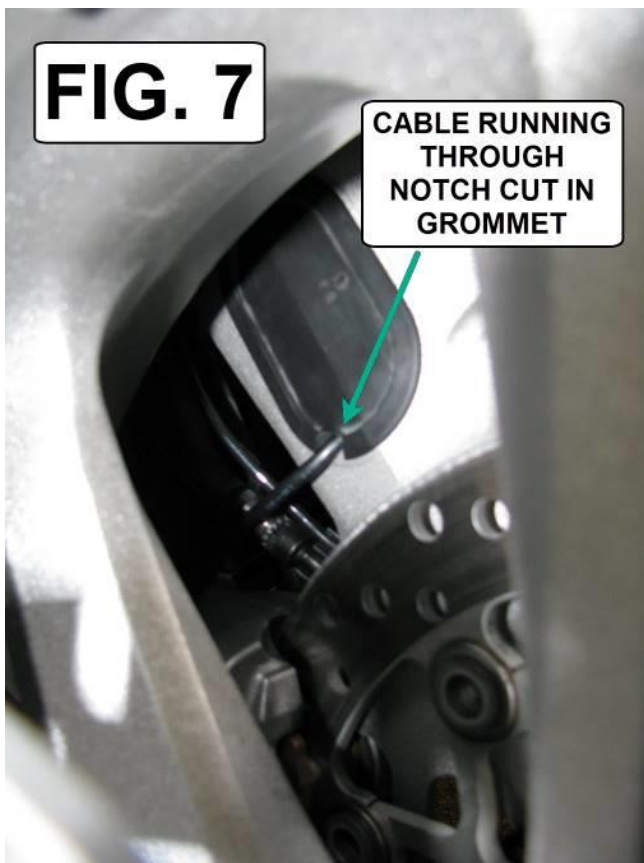

CABLE RUNNING THROUGH NOTCH CUT IN GROMMET

**NOTICE**

BIG BIKE PARTS RECOMMENDS INSTALLING AN ISOLATION FUSE BLOCK (PART NUMBER 52-942) BEFORE CONNECTING ANY ADDED ELECTRICAL ACCESSORIES TO THE BIKE

**FIG. 8**

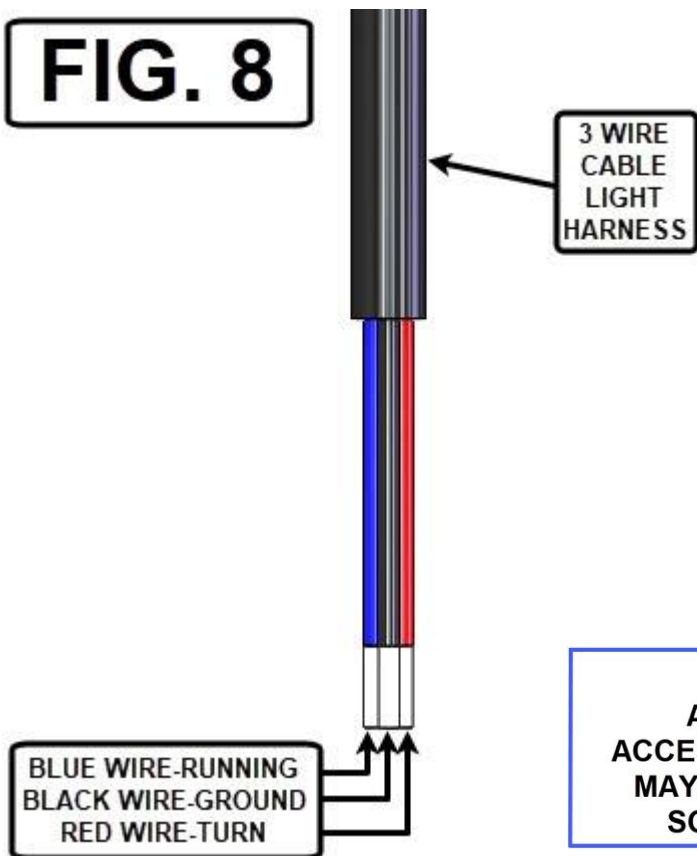

3 WIRE CABLE LIGHT HARNESS

BLUE WIRE-RUNNING  
BLACK WIRE-GROUND  
RED WIRE-TURN

**NOTICE**

ADDING MULTIPLE ACCESSORIES TO A CIRCUIT MAY CAUSE ISSUES WITH SOME ACCESSORIES