

Instruction 510-0226
09-03-13

S&S[®] Cycle, Inc.

14025 Cty Hwy G PO Box 215
Viola, Wisconsin 54664

Phone: 608-627-1497 • Fax: 608-627-1488
Technical Service Phone: 608-627-TECH (8324)
Technical Service Email: sstech@sscycle.com
Website: www.sscycle.com



Copyright ©2013
by S&S[®] Cycle, Inc.

All rights reserved.
Printed in the U.S.A.

Installation Instructions: S&S Stealth Air Cleaner Covers

DISCLAIMER:

S&S parts are designed for high performance, closed course, racing applications and are intended for the very experienced rider only. The installation of S&S parts may void or adversely affect your factory warranty. In addition such installation and use may violate certain federal, state, and local laws, rules and ordinances as well as other laws when used on motor vehicles used on public highways, especially in states where pollution laws may apply. Always check federal, state, and local laws before modifying your motorcycle. It is the sole and exclusive responsibility of the user to determine the suitability of the product for his or her use, and the user shall assume all legal, personal injury risk and liability and all other obligations, duties, and risks associated therewith.

The words Harley[®], Harley-Davidson[®], H-D[®], Sportster[®], Evolution[®], and all H-D part numbers and model designations are used in reference only. S&S Cycle is not associated with Harley-Davidson, Inc.

SAFE INSTALLATION AND OPERATION RULES:

Before installing your new S&S part it is your responsibility to read and follow the installation and maintenance procedures in these instructions and follow the basic rules below for your personal safety.

- Gasoline is extremely flammable and explosive under certain conditions and toxic when breathed. Do not smoke. Perform installation in a well ventilated area away from open flames or sparks.
- If motorcycle has been running, wait until engine and exhaust pipes have cooled down to avoid getting burned before performing any installation steps.
- Before performing any installation steps disconnect battery to eliminate potential sparks and inadvertent engagement of starter while working on electrical components.
- Read instructions thoroughly and carefully so all procedures are completely understood before performing any installation steps. Contact S&S with any questions you may have if any steps are unclear or any abnormalities occur during installation or operation of motorcycle with a S&S part on it.
- Consult an appropriate service manual for your motorcycle for correct disassembly and reassembly procedures for any parts that need to be removed to facilitate installation.
- Use good judgment when performing installation and operating motorcycle. Good judgment begins with a clear head. Don't let alcohol, drugs or fatigue impair your judgment. Start installation when you are fresh.
- Be sure all federal, state and local laws are obeyed with the installation.
- For optimum performance and safety and to minimize potential damage to carb or other components, use all mounting hardware that is provided and follow all installation instructions.
- Motorcycle exhaust fumes are toxic and poisonous and must not be breathed. Run motorcycle in a well ventilated area where fumes can dissipate.

IMPORTANT NOTICE:

Statements in this instruction sheet preceded by the following words are of special significance.

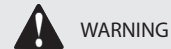

WARNING

Means there is the possibility of injury to yourself or others.



CAUTION

Means there is the possibility of damage to the part or motorcycle.

NOTE

Other information of particular importance has been placed in italic type.

S&S recommends you take special notice of these items.

WARRANTY:

All S&S parts are guaranteed to the original purchaser to be free of manufacturing defects in materials and workmanship for a period of twelve (12) months from the date of purchase. Merchandise that fails to conform to these conditions will be repaired or replaced at S&S's option if the parts are returned to us by the purchaser within the 12 month warranty period or within 10 days thereafter.

In the event warranty service is required, the original purchaser must call or write S&S immediately with the problem. Some problems can be rectified by a telephone call and need no further course of action.

A part that is suspect of being defective must not be replaced by a Dealer without prior authorization from S&S. If it is deemed necessary for S&S to make an evaluation to determine whether the part was defective, a return authorization number must be obtained from S&S. The parts must be packaged properly so as to not cause further damage and be returned prepaid to S&S with a copy of the original invoice of purchase and a detailed letter outlining the nature of the problem, how the part was used and the circumstances at the time of failure. If after an evaluation has been made by S&S and the part was found to be defective, repair, replacement or refund will be granted.

ADDITIONAL WARRANTY PROVISIONS:

- (1) S&S shall have no obligation in the event an S&S part is modified by any other person or organization.
- (2) S&S shall have no obligation if an S&S part becomes defective in whole or in part as a result of improper installation, improper maintenance, improper use, abnormal operation, or any other misuse or mistreatment of the S&S part.
- (3) S&S shall not be liable for any consequential or incidental damages resulting from the failure of an S&S part, the breach of any warranties, the failure to deliver, delay in delivery, delivery in non-conforming condition, or for any other breach of contract or duty between S&S and a customer.
- (4) S&S parts are designed exclusively for use in Harley-Davidson[®] and other American v-twin motorcycles. S&S shall have no warranty or liability obligation if an S&S part is used in any other application.

Kit Contents:

- Air Cleaner Cover



WARNING



- **The safety of the motorcycle rider is dependent of proper installation of this product. If you are not certain of your capabilities or do not have the correct tools for this installation, please consult a shop to have it done. Improper installation of this product could result in injury or death to the rider.**

Installation

Installing S&S® Air Cleaner Covers With Single Center Mounting Bolt

1. Attach an S&S air cleaner cover to the stealth air cleaner kit by installing the $\frac{5}{16}$ " button head screw with 243 blue Loctite® applied to the threads and torque to 10 ft.-lbs. as illustrated in **Picture 1**.
2. If your cover comes with a small cap and o-ring, as illustrated in **Picture 2**, apply a small amount of grease to the o-ring and install around the center cap groove as illustrated in **Picture 3**.
3. Push the cap into the air cleaner cover until you feel the cap snap into place.

Installing the S&S Muscle Air Cleaner Cover for E&G Carburetors using S&S Stealth Air Cleaner Kit

1. This step should only be done if you are installing the S&S Muscle cover on an S&S E or G carburetor. Remove the lanyards from the supplied gasket by squeezing the rivets on the small end with a pair of pliers as illustrated in **Picture 4**. This gasket will not be needed for the installation on the E&G carburetors.
2. Remove the two flanged head screws from the filter top plate and the $\frac{5}{16}$ " button head screw as illustrated in **Picture 5**.
3. Install the two threaded pin studs in place of where the flanged head screws were removed. A small amount of 243 blue Loctite® should be applied to the threads of the pin stud. **Picture 6** illustrates the pin studs.
4. Tighten the pin studs down and make sure the holes are horizontal. **Picture 7** illustrates the pin studs installed and the holes in a horizontal position with the lynch pins installed.
5. If the lynch pins are not sitting straight on the pin studs take this time adjust them to the desired location.
6. Remove the lynch pins from the pin studs.
7. Attach the lanyards to the carburetor using the carburetor bowl screws pointed out in **Picture 8**.
8. Remove one screw at a time and tighten down making sure the eyelets and cables are pointed outward and not interfering with the backplate or the carburetor.

NOTE: **Picture 9** illustrates the carburetor without the backplate and filter assembly but you should be able to install the lanyards with the backplate and filter assembly on the carburetor and attached to the motorcycle.

9. Install the Muscle cover over the pin studs followed by a flat washer, a spring washer, a flat washer and the lynch pin. **Picture 10** illustrates the Muscle cover assembled on the motorcycle.
10. **Picture 11** illustrates a diagram of the Muscle cover and parts assembly.



Picture 1



Picture 2



Picture 3



Picture 4

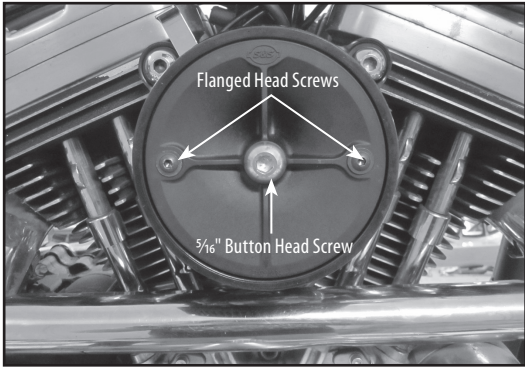

Picture 5

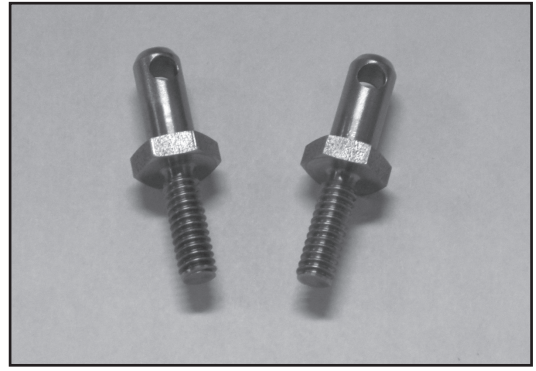

Picture 6

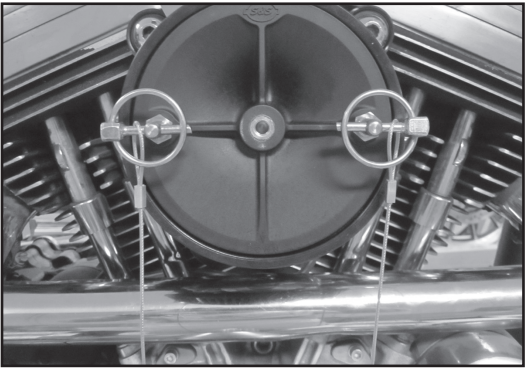

Picture 7

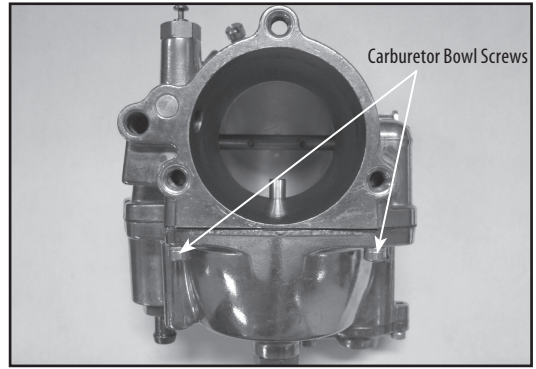

Picture 8

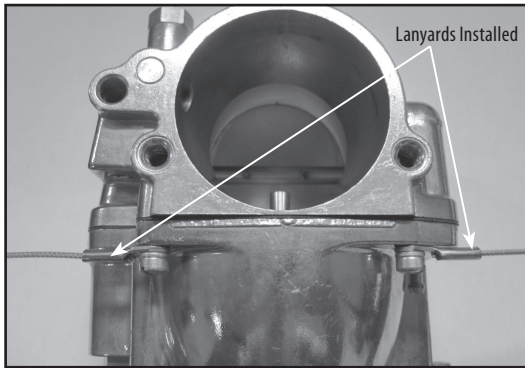

Picture 9

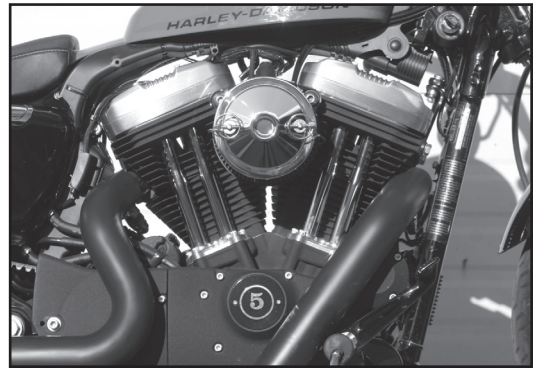

Picture 10

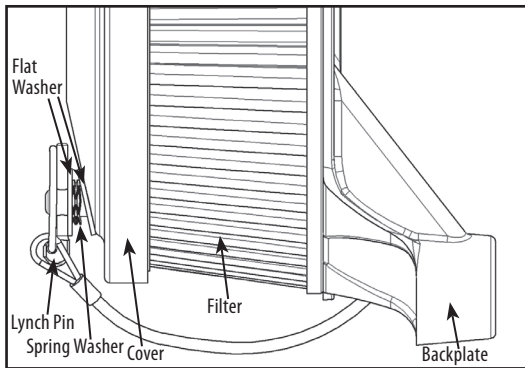

Picture 11

Installing the S&S® Muscle Air Cleaner Cover for Stock CV Carburetors, Stock Delphi EFI and Stock Throttle by Wire Throttle bodies using the S&S Stealth Air Cleaner Kit

1. Remove the air cleaner assembly from the motorcycle you are working on.
2. Locate the gasket that has the lanyards attached. **Picture 12** illustrates the lanyard gasket.
3. Slide the lanyard gasket over the screws as illustrated in **Picture 13**.
4. Pass the breather bolts through the backplate mounting holes using the same number of rubber coated washers that were used prior to disassembly.
5. Apply a drop of 243 blue Loctite® to the threads of each screw and breather bolt. **Picture 14** illustrates all five fasteners that require 243 blue Loctite.
6. Fit the backplate to the carburetor or throttle body and the cylinder heads. Start the threads of all the screws and tighten evenly until the backplate is snug.
7. Now that the backplate is positioned, finish torque the ¼" X 20 fasteners to 72 in.-lbs. as illustrated in **Picture 15**.
8. Thread the breather bolts in and finish torque breather bolts to 10-12 ft.-lbs.
9. Remove the 5/16" button head screw from the plastic top filter plate if it has not been already. **Picture 14** illustrates the button head screw. Hold the filter on the backplate and put the filter top plate on top of the filter making sure that the word "Down" is facing down and sitting flat on the filter and locked into the groove as illustrated in **Picture 16**.
10. Install the two threaded pin studs in place of where the flanged head screws were removed at disassembly. A small amount of 243 blue Loctite® should be applied to the threads of the pin stud. **Picture 17** illustrates the pin studs.
11. Tighten the pin studs down and make sure the holes are horizontal. **Picture 18** illustrates the pin studs installed and the holes in a horizontal position with the lynch pins installed.
12. If the lynch pins are not sitting straight on the pin studs take this time adjust them to the desired location.
13. Remove the lynch pins from the pin studs.
14. Install the Muscle cover over the pin studs followed by a flat washer, a spring washer, a flat washer and the lynch pin. **Picture 19** illustrates the Muscle cover assembled on the motorcycle.
15. **Picture 20** illustrates a diagram of the Muscle cover and parts assembly.

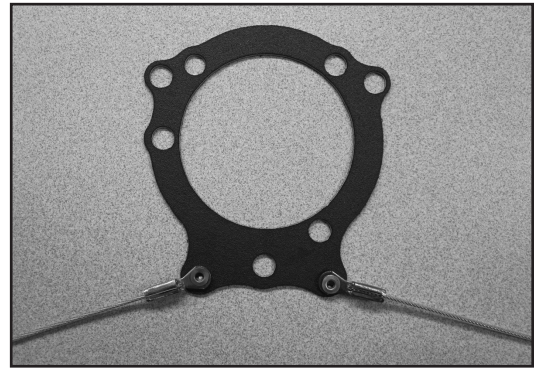

Picture 12



Picture 13



Picture 14



Picture 15

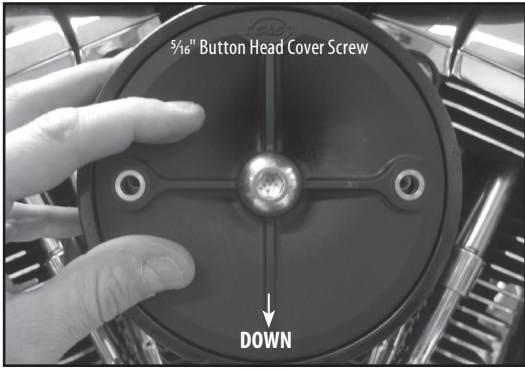

Picture 16

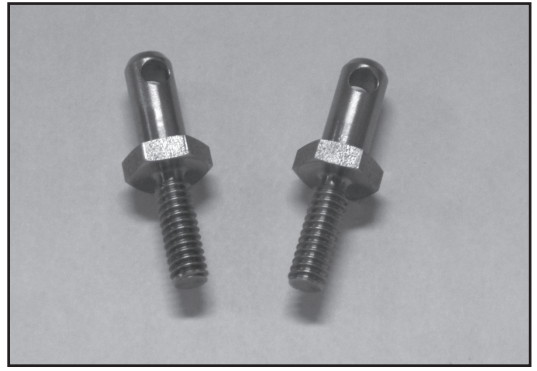

Picture 17

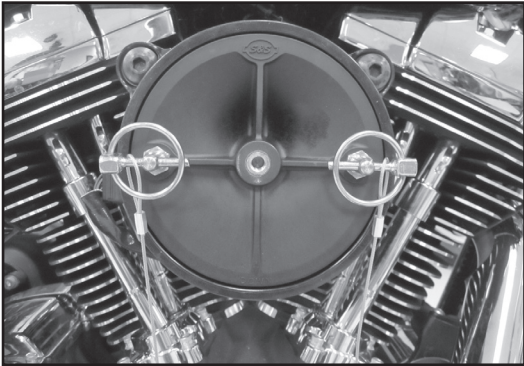

Picture 18

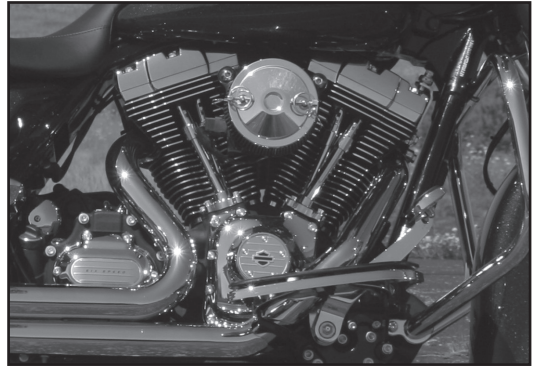

Picture 19

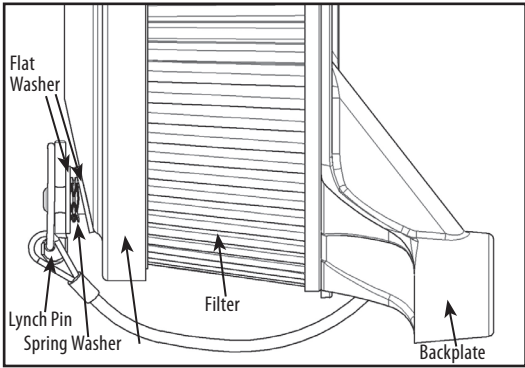

Picture 18

S&S® Air Cleaner Covers

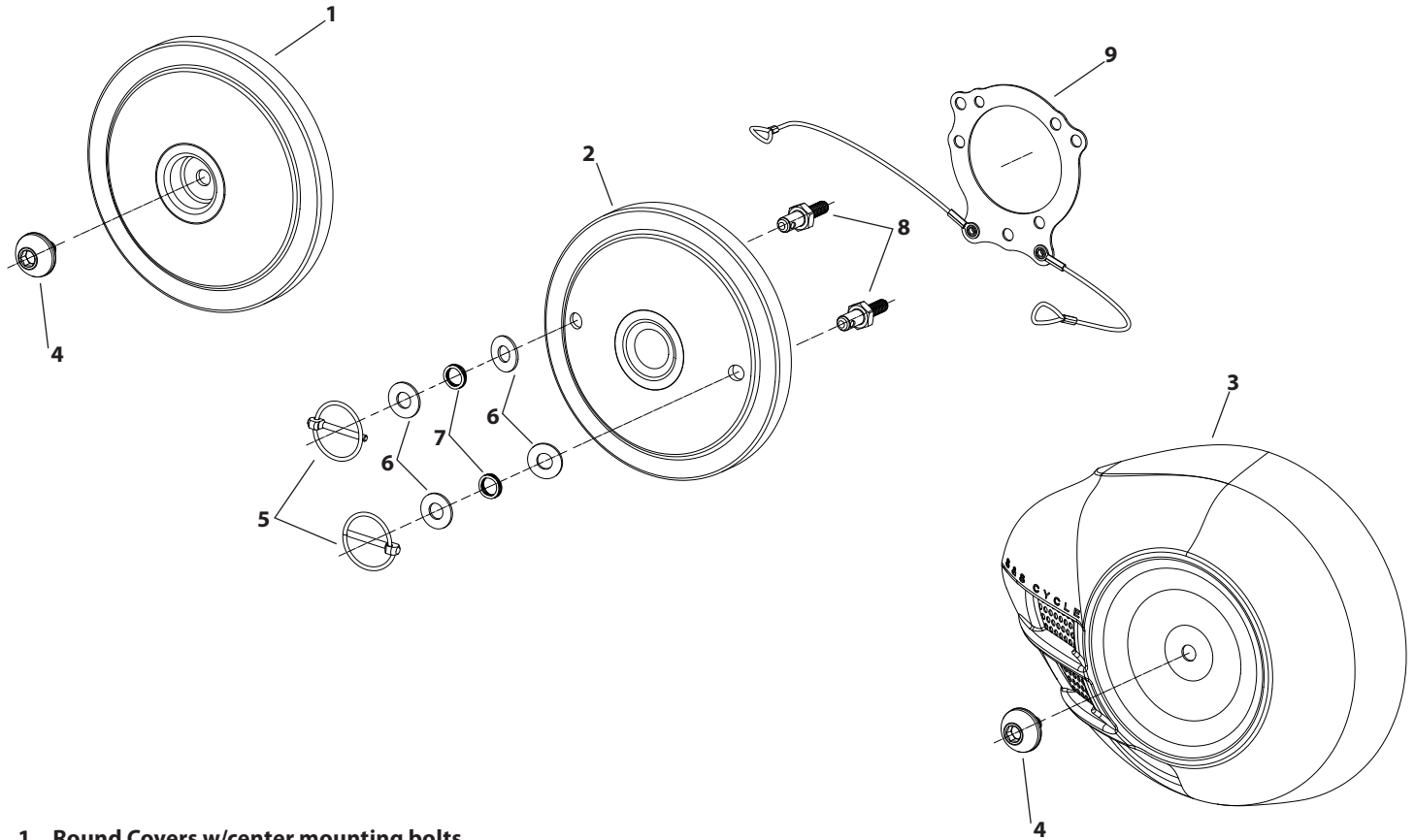

1. Round Covers w/center mounting bolts

a. Bobber Dished

- Black Jack170-0123
- Chrome170-0119

b. Bobber Domed

- Black Jack170-0124
- Chrome170-0120

c. Torker Cover.....170-0206

d. Tri-Spoke Cover170-0210

e. Air 1 Cover.....170-0214

2. Muscle

- Black Jack170-0136
- Chrome170-0172

3. Airstream

- Black Jack170-0122
- Chrome170-0118

4. Screw, SHCB, 5/16-18 x .500", Polished, Stainless Steel.....500-0051

5. Pin, Lynch, .125" x .84", Usable Length (Each) 2 required500-0083

6. Washer, Fender, .344" x .750" x .050", Chrome Plated, Steel (Each) 4 required 500-0094

7. Spring, Wave, .012" Wire, .312" x .060" x .240", Stainless Steel (Each) 2 required500-0093

8. Screw, Hex, Hood Pin, Electro Polish, 1/4-20 UNC X 1.60", Stainless Steel (Each) 2 required..... 500-0113

9. Gasket, Backplate, Throttle Body, Stock CV/EFI, Throttle-by-Wire, Lanyard Style, 1991-Up xl/bt.....170-0137

