

> Instructions

Thule RideAlong Lite 100109, 100110, 100111

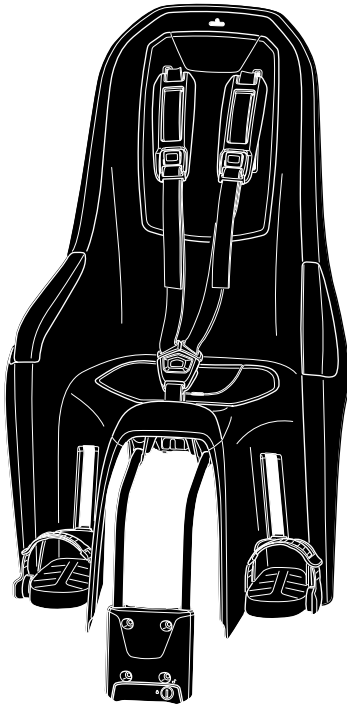

EN Child bike seat
DE Fahrradkindsitz
FR Siège vélo enfant
NL Fietszitje
IT Seggiolino da bici
ES Portabebés bici
PT Cadeira de criança para bicicleta
SV Cykelbarnstol
DK Cykelstol
NO Barnesete til sykkel
FI Polkupyörän lastenistuun
ET Jalgratta lasteiste
LV Velosipēda bērnu sēdekļis
LT Dviračio kėdutė vaikams
PL Fotelik rowerowy
RU Детское велосипедное сиденье
UK Дитяче велосипедне крісло
BG Детско столче за велосипед
CS Dětská cyklosedačka
SK Detská cyklosedačka
SL Otroški kolesarski sedež
HR/BIH Dječja sjedalica za bicikl

RO Scaun de copii pentru bicicletă
HU Kerékpáros gyerekülés
EL Παιδικό κάθισμα ποδηλάτου
TR Çocuk bisiklet koltuğu

HE כיסא אופניים לילד
AR مقعد دراجة الطفل

ZH 儿童自行车座椅
JA お子様用サイクルシート
KO 어린이 자전거 시트
TH เก้าอี้เด็กสำหรับจักรยาน

ASTM F1625-00

EN 14344:2004

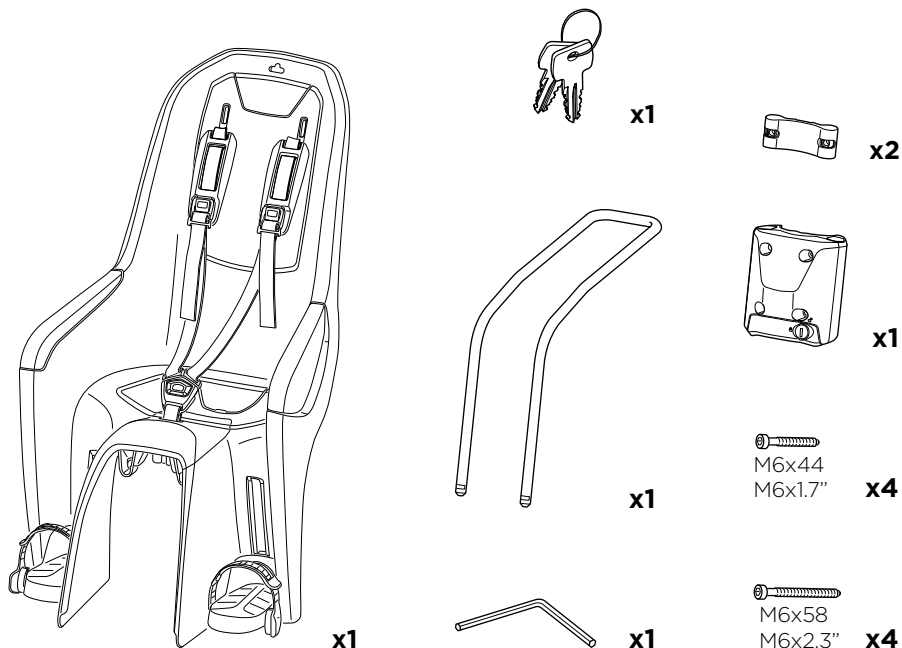
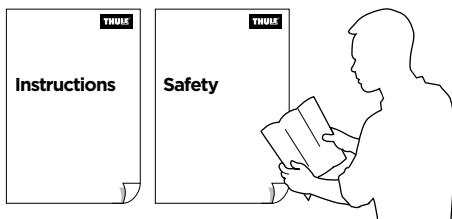



FIT

Europe & rest of the world

USA & Canada

9-72 M
9-22 kg
20-48,5 lbs

9-72 M
9-18 kg
20-40 lbs



Your Key-Number

Four empty boxes for entering a key number.



NO FIT



0-9 M



Check your bike : A.2

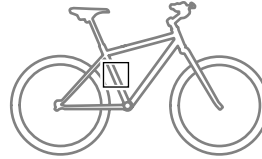

FIT

Circular



Ø 28-40 mm
Ø 1,10-1,57"

Oval



Max 40 mm
Max 1,57"



NO FIT

Triangular



Square

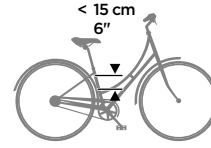
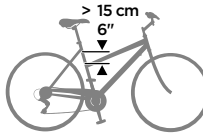

Ok



No ok

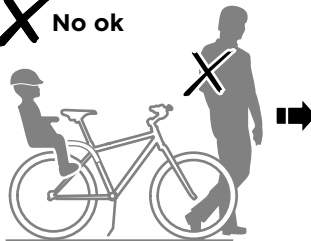

Max. 25 km/h
15 mph

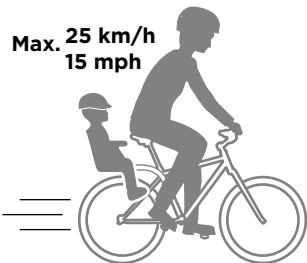

No ok



1

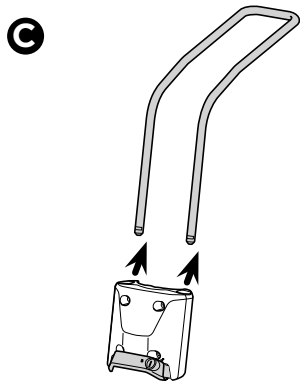
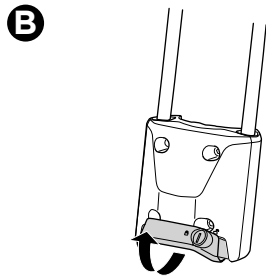
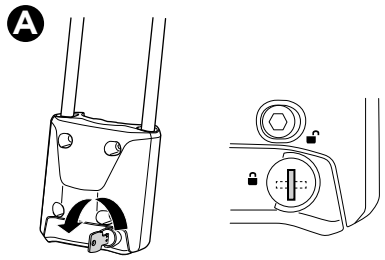
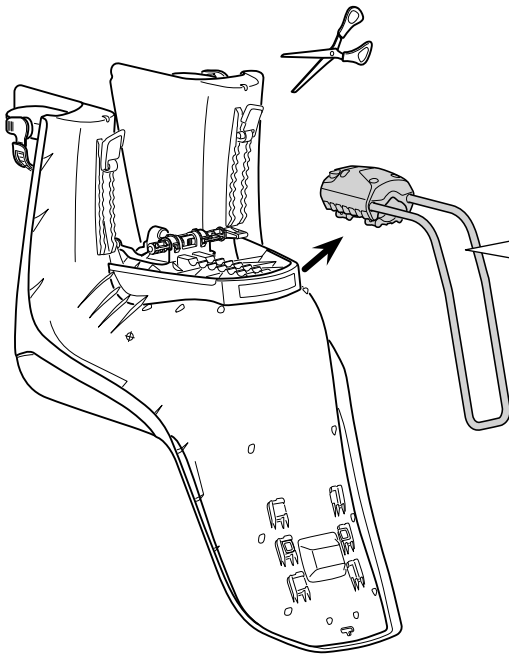

2

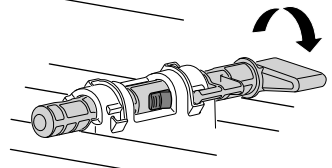
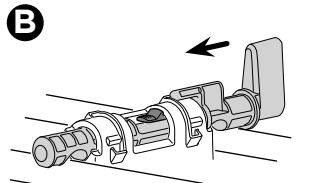
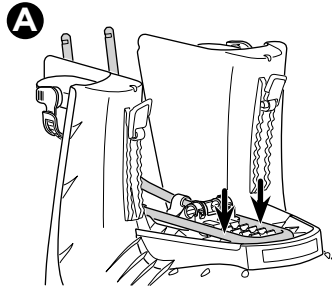
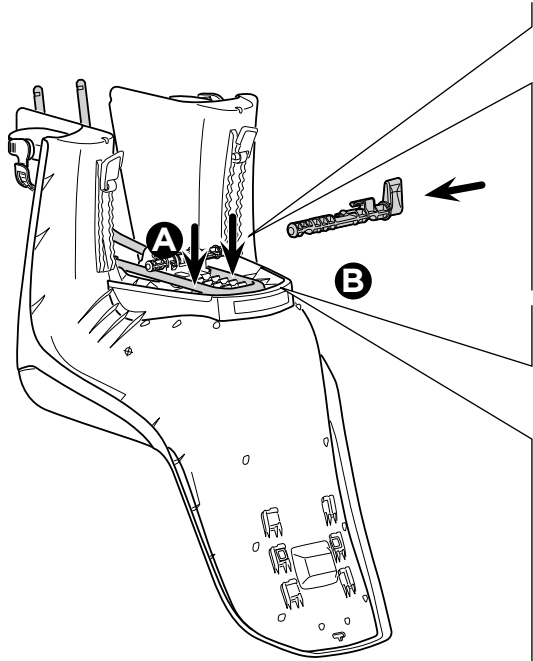
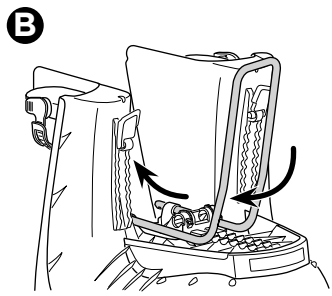
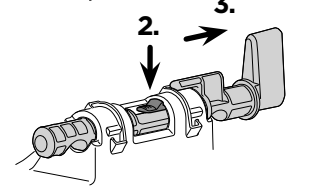
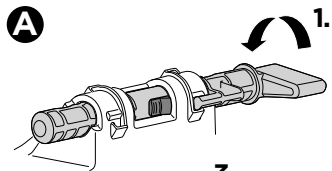
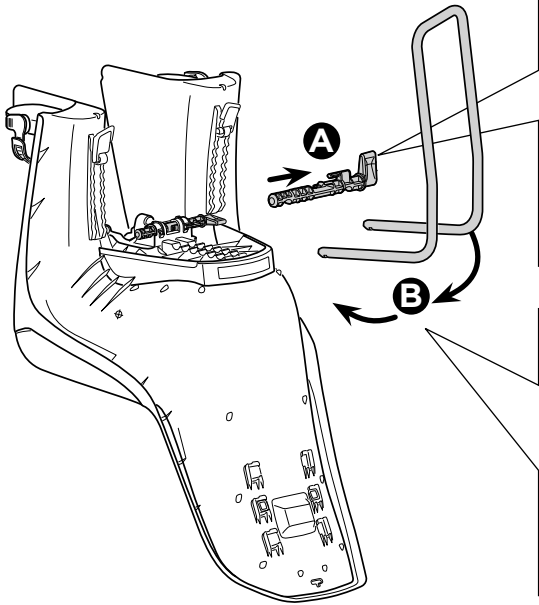

3

i

Ø 27.2-40 mm
Ø 1.07-1.57"

40x55 mm
1.57-2.16"

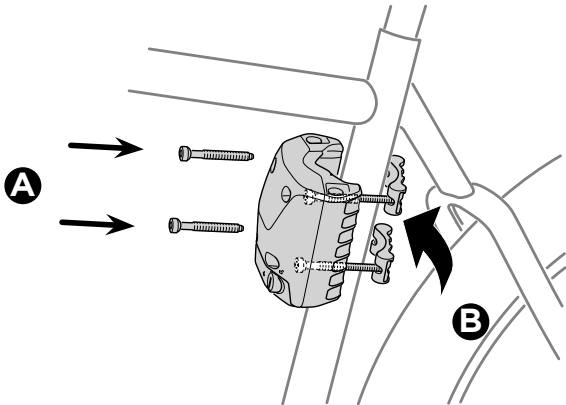
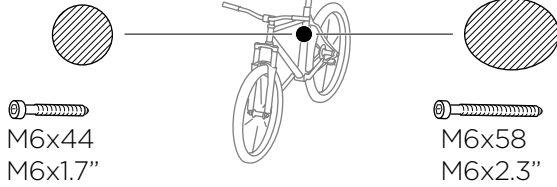

C

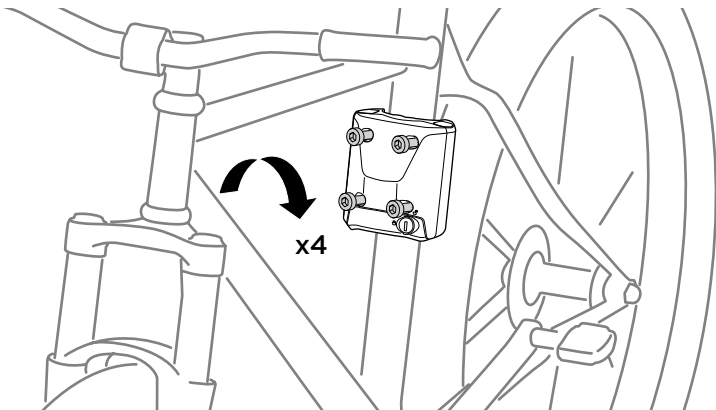

4

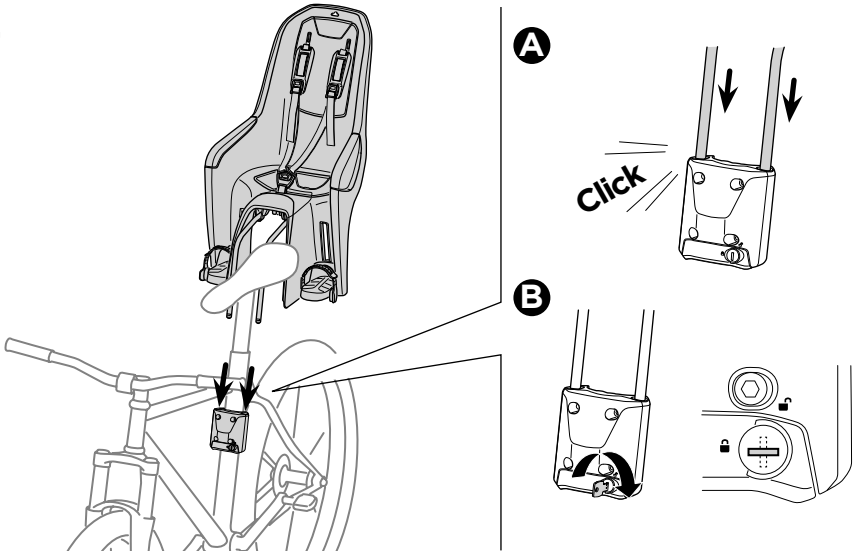

5

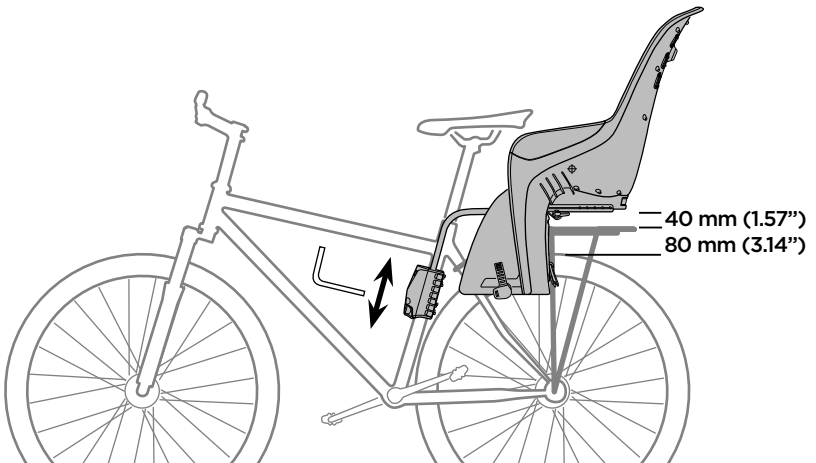

8 Nm



x4

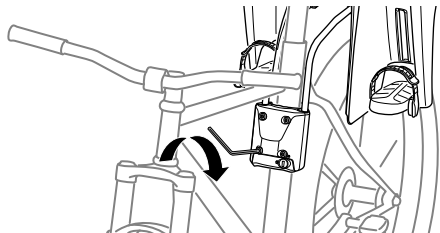

6

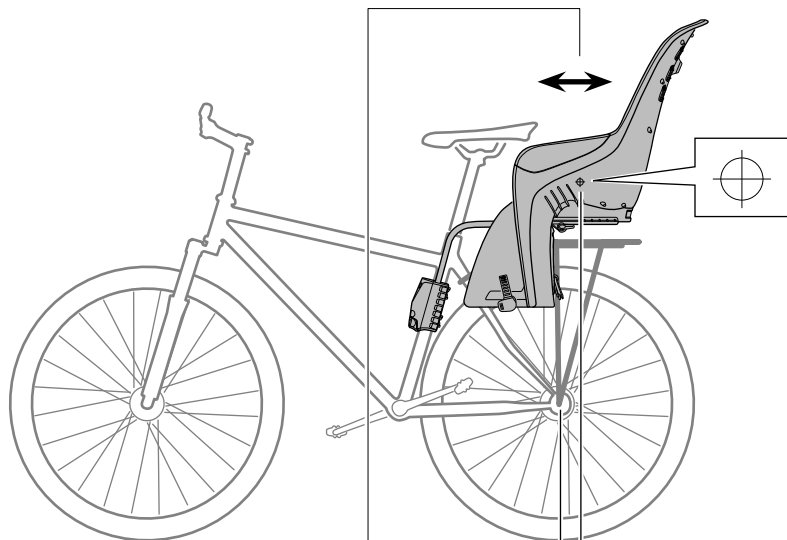
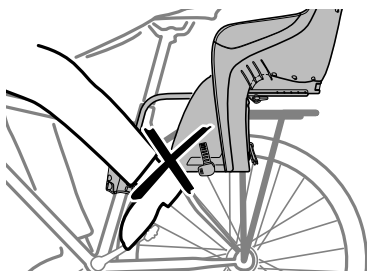

* max 100 mm
max (3.94")

* DE max 0 mm

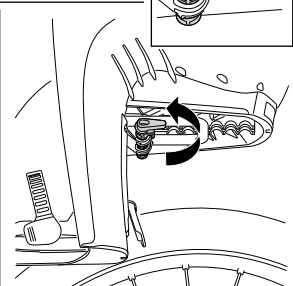
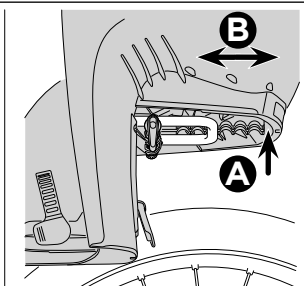
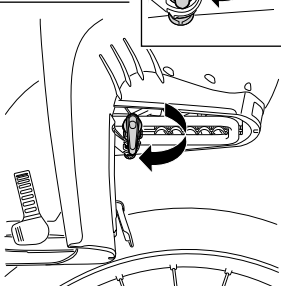
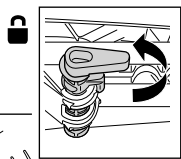
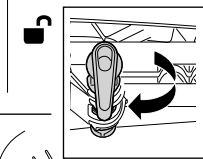

7

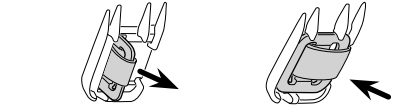
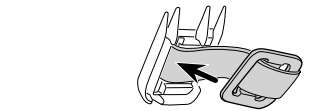
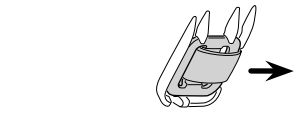
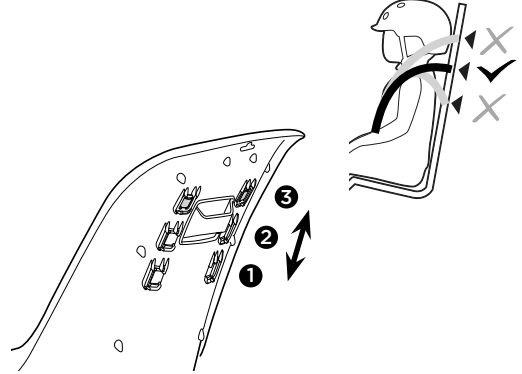
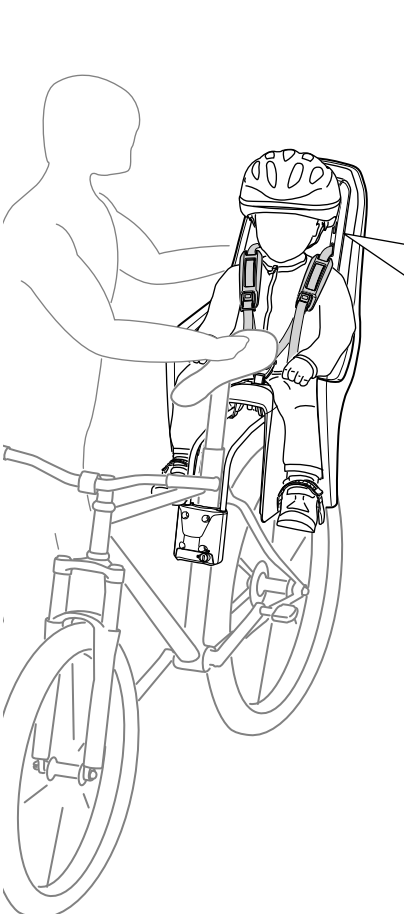
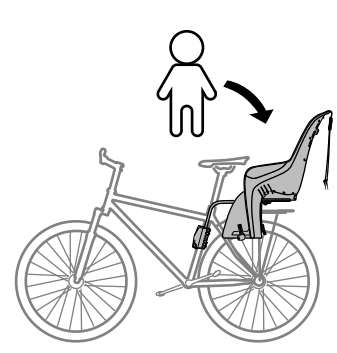
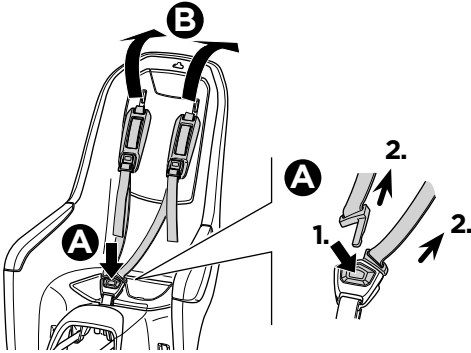

8

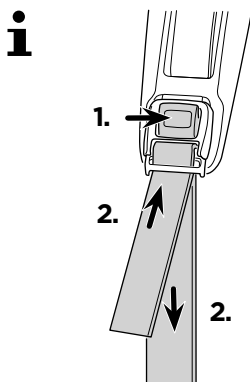
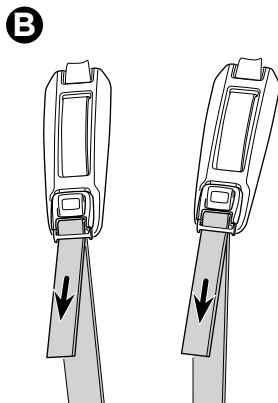
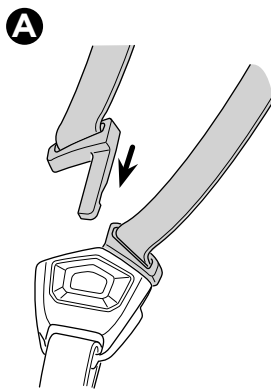
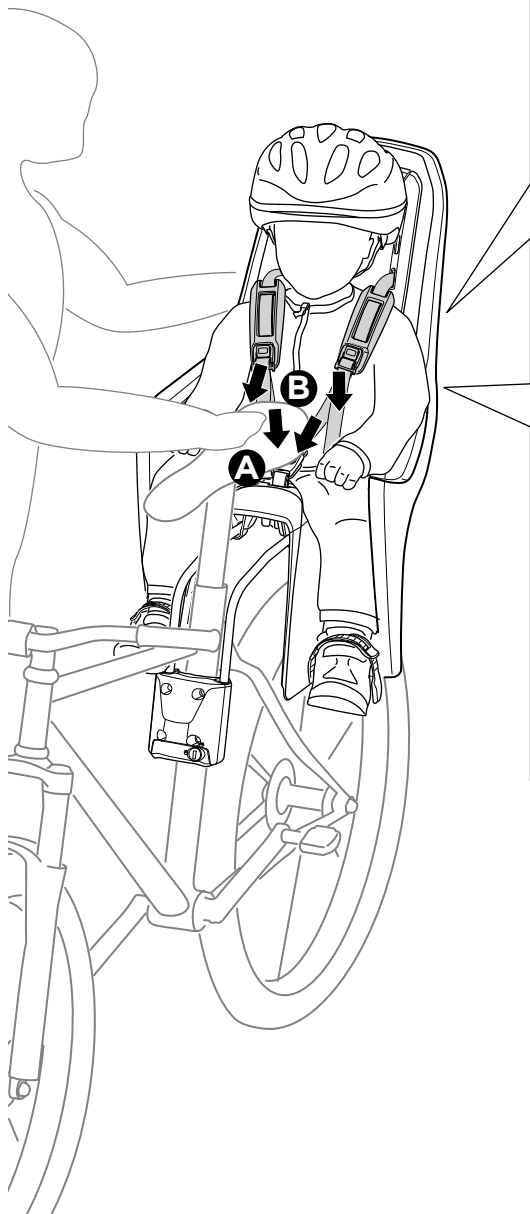

9

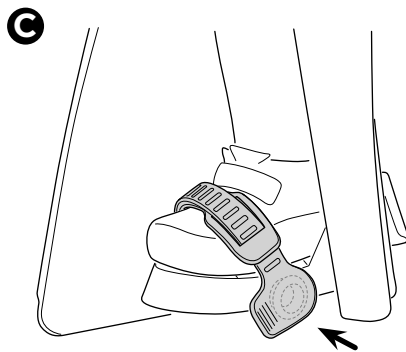
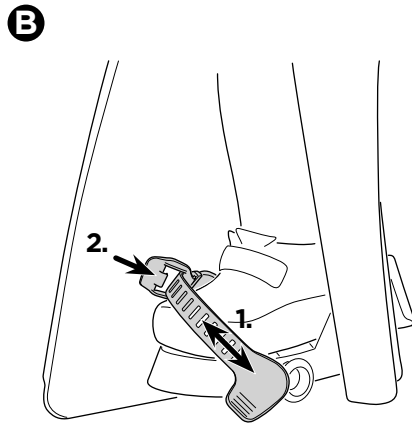
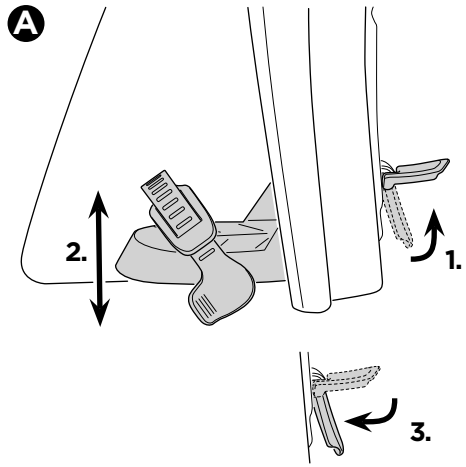
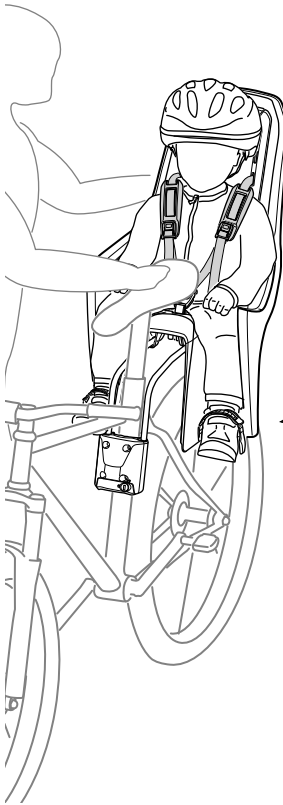

i

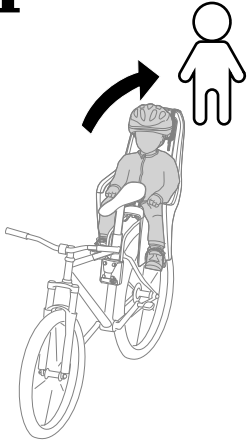

A



B

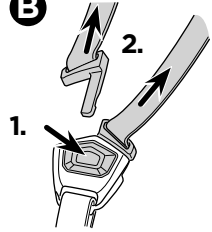

C



D

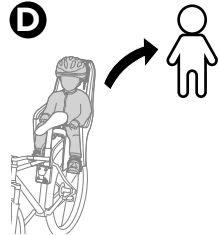

A

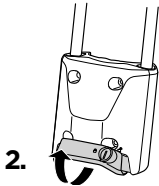
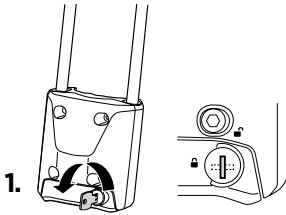

B

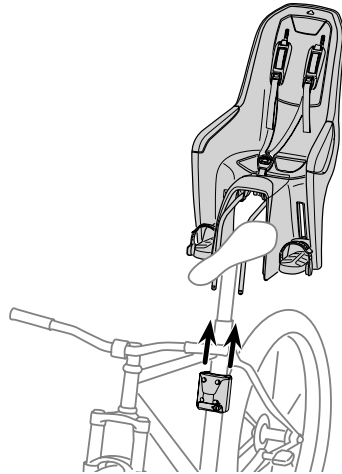

Thule One-Key System

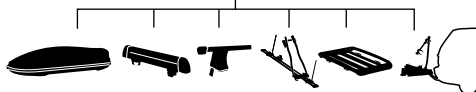

450400 (x4)

450600 (x6)

450800 (x8)

451200 (x12)