

266B

EN

Electronic torque wrench

SLO

Ključ momentni,  
elektronski



 **UNIOR**<sup>®</sup>  
BIKE TOOLS

[uniorbiketools.com](http://uniorbiketools.com)

Thank you for purchasing Unior Electronic torque wrench. This manual will help you understand and use all the features of your new digital torque wrench. **Before operating the torque wrench, please read this manual completely**, and keep it at hand for future reference.

### MAIN FEATURES & SPECIFICATIONS

- Digital torque value readout
- CW (clockwise) and CCW (counterclockwise) operation
- Peak hold and track mode operation mode
- Buzzer and LED indicator
- Units selection N-m, ft-lb, in-lb, kg-cm
- Auto power off after about 5 minutes idle
- Compatible with rechargeable batteries
- Battery: 1 x AAA
- Operating temperature: -10°C - 60°C
- Storage temperature: -20°C - 70°C

Code	Model	Range (Nm)	Square drive	Accuracy
627785	266B	4.3 – 85	1/2"	+/- 3 % CW
627784	266B	1 – 20	1/4"	+/- 4 % CCW

### UNIOR ELECTRONIC TORQUE WRENCH EXPLAINED

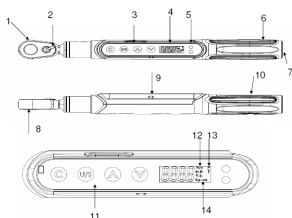

1. Ratchet head
2. Direction lever
3. Communication port
4. LCD display
5. LED indicator
6. Anti-slip handle
7. Battery cover
8. Square drive
9. Buzzer
10. Calibration mark
11. Buttons
12. Torque Value
13. Peak/Track mode
14. Units

### USING TORQUE WRENCH FOR THE FIRST TIME

#### BATTERY INSTALLATION

- Remove the battery cover
- Insert one AAA battery and orientate the poles of battery according to the figure below.
- Install the battery cover and fasten it tightly according to the following figure.

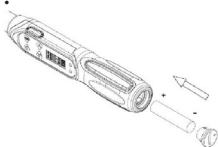

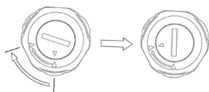

### POWER ON AND RESETTING THE WRENCH

- Press **C** to power on the torque wrench.
- Press **C** to reset the digital torque wrench before using it.



### RESETTING TORQUE WRENCH

In case electronic torque wrench doesn't work normally, remove the battery cover and install it back on.



#### IMPORTANT - Low battery (ONLY FOR dim. 1 - 20Nm)

- When battery level is too low, wrench will display blinking bat/Lo message.
- When this message is displayed, please replace battery immediately. Use only high quality batteries.
- When low battery message is displayed, wrench automatically enters battery saving mode. Battery saving mode disables the LEDs and buzzer to save battery power and prevent torque wrench from crashing due to lack of power from the battery. Battery power mode engagement is indicated with a very short beeping sound.

#### ATTENTION:

If an external force is applied to the torque wrench during power-on period, an initial torque offset will be recorded in the memory.

- C** Power on/clear
- U/S** Unit selection/Setting
- ^** Adjust torque value up
- v** Adjust torque value down

#### STEP 1: UNIT SELECTION



Pre-set unit: N·m

Press **U/S**



Unit selection: in·lb

Press **U/S**



Unit selection: ft·lb

Press **U/S**



Unit selection: kg·cm

**STEP 2: SET TARGET TORQUE**



**STEP 3: PEAK HOLD /TRACK MODE SELECTION**

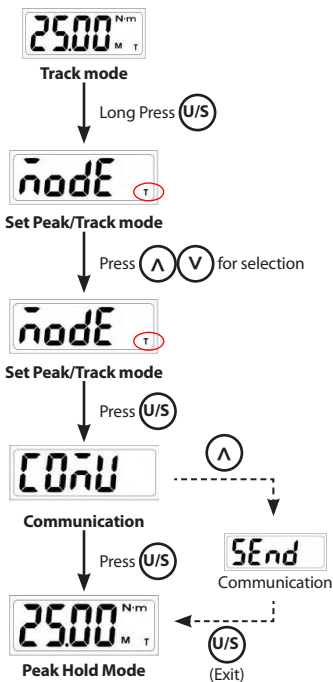

**NOTE:**

Communication function is used for calibration of the torque wrench. Please contact your local dealer for more information.

## TRACK MODE OPERATION

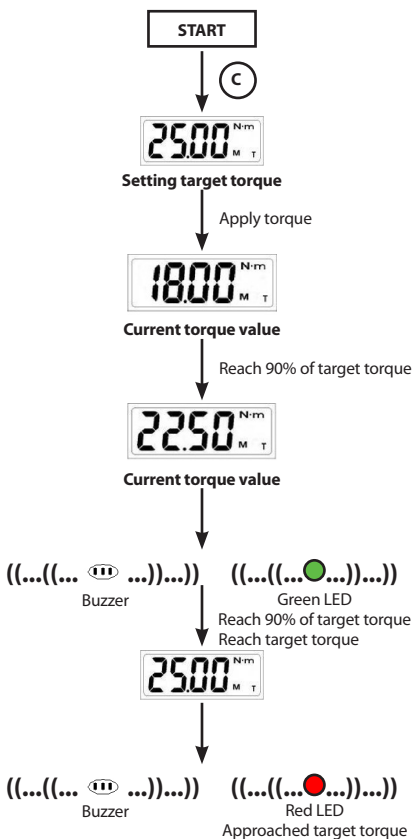

### NOTE:

1. If **Er0** appears, that means this wrench has been applied with more than 110% of torque of the spec.
2. When 90% of the target torque is reached, the green LED will begin to flash and the alarm tone will beep intermittently.
3. When 99.5% of the target torque has been reached, the alarm will change to a steady tone and the green LED will stop flashing and stay on. The red LED will also illuminate.

## PEAK HOLD MODE OPERATION

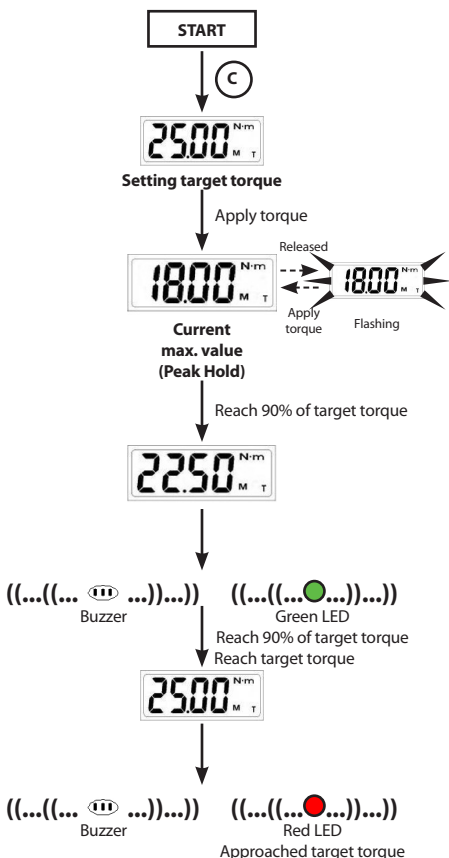

### NOTE:

1. If **Er0** appears, that means this wrench has been applied with more than 110% of torque of the spec.
2. When 90% of the target torque is reached, the green LED will begin to flash and the alarm tone will beep intermittently.
3. When 99.5% of the target torque has been reached, the alarm will change to a steady tone and the green LED will stop flashing and stay on. The red LED will also illuminate.

## MAINTENANCE AND STORAGE

### ATTENTION:

One-year periodic recalibration is necessary to maintain accuracy.  
Please contact your local dealer for calibration.

**CAUTION:**

- 1. Over-torque (110% of max. torque range) could cause breakage or lose accuracy.**
2. Do not shake violently or drop wrench.
3. Do not use this wrench as a hammer.
4. Do not leave this wrench in any place exposed to excessive heat, humidity, or direct sunlight.
5. Do not use this apparatus in water as it is not waterproof.
6. If the wrench gets wet, wipe it with a dry towel as soon as possible. The salt in seawater can be especially damaging.
7. Do not use organic solvents, such as alcohol or paint thinner when cleaning the wrench.
8. Keep this wrench away from magnets.
9. Do not expose this wrench to dust or sand as this could cause serious damage.
10. Do not apply excessive force to the LCD panel.
11. Apply torque slowly and grasp the center of the handle. Do not apply load to the end of handle.

**BATTERY MAINTENANCE**

1. When the wrench is not used for an extended period of time, remove the battery
2. Keep a spare battery on hand when going on a long trip or to cold areas
3. Sweat, oil and water can prevent a battery's terminal from making electrical contact. To avoid this, wipe both terminals before loading a battery.
- 4. Dispose batteries in a designated disposal area or containers**
5. Do not throw batteries into a fire

**SLO**

Hvala, da ste se odločili za nakup Uniorjevega elektronskega momentnega ključa. Navodila vam bodo pomagala razumeti funkcije vašega novega elektronskega momentnega ključa. Pred uporabo v celoti preberete navodila in jih shranite za kasnejši vpogled.

**GLAVNE ZNAČILNOSTI IN SPECIFIKACIJE**

- Digitalni izpis vrednosti momenta
- Delovanje v obe smeri - v desno in v levo
- Način delovanja Peak in Track
- Zvočni in LED indikator
- Izbira enote N-m, ft-lb, in-lb, kg-cm
- Samodejni izklop po petih minutah mirovanja
- Združljiv s polnilnimi baterijami
- Baterija: 1 x AAA
- Temperatura delovanja: -10 °C do 60 °C
- Temperatura za shranjevanje: -20 °C do 70 °C

Koda	Naziv	Razpon (Nm)	Velikost štirikota	Natančnost
627785	266B	4.3– 85	1/2"	+/- 3 % D
627784	266B	1 – 20	1/4"	+/- 4 % L

## RAZLAGA FUNKCIJ UNIORJEVEGA ELEKTRONSKEGA MOMENTNEGA KLJUČA

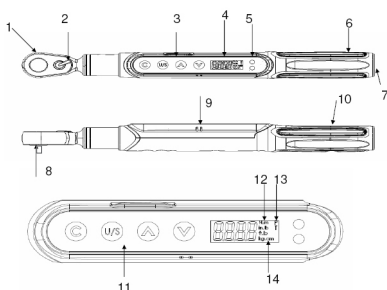

1. Raglja
2. Gumb za spreminjanje smeri vijačenja
3. Komunikacijska vrata
4. LCD zaslon
5. LED opozorilne lučke
6. Nedrseč ročaj
7. Pokrov baterije
8. Štirikot
9. Zvočni opozorilnik (brenčoč)
10. Kalibracijska točka
11. Gumbi
12. Prikaz vrednosti momenta
13. Način delovanja Peak/Track
14. Prikaz izbrane enote

### PRED PRVO UPORABO

#### NAMESTITEV BATERIJE

- Odstranite pokrov baterije.
- Vstavite baterijo velikosti AAA (1 kos) s poloma orientiranimi kot prikazuje spodnja skica.
- Namestite pokrov baterije in ga privijte kot prikazuje spodnja skica.

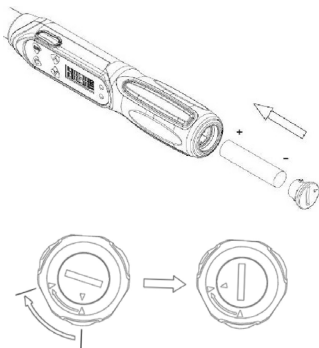

#### VKLOP IN PONAŠTAVLJENJE MOMENTNEGA KLJUČA

- Pritisnite **C**, da prižgete momentni ključ.
- Pritisnite **C**, da ponastavite momentni ključ pred uporabo.







### **POMEMBNO - Prazna baterija (SAMO ZA dim. 1 - 20Nm)**

- V primeru prazne baterije, bo ključ prikazoval utripajoče sporočilo bat/Lo.
- Ob prikazu tega sporočila, prosimo nemudoma zamenjajte baterijo. Uporabite zgolj visoko kakovostne baterije.
- V primeru prikaza sporočila prazne baterije, ključ samodejno stopi v program varčevanja z energijo baterije. Varčevalni program onemogoči delovanje LED prikaza in piskanja, z namenom preprečitve izgube podatkov in nastavitvev ključa, zaradi prenizkega stanja energije baterije. Program varčevanja z energijo je nakazan s kratkim piskom.

### **POZOR:**

Če bo v času prižiganja momentnega ključa nanj delovala sila, se lahko ta zamik začetnega navora zabeleži v spomin.

### **AVTOMATSKI IZKLOP**

Momentni ključ se bo po petih minutah mirovanja samodejno izklopil. Za ponoven vklop pritisnite .

### **PONASTAVLJENJE MOMENTNEGA KLJUČA**

Če momentni ključ ne deluje normalno, odstranite pokrov baterije in ga ponovno namestite.



**Vklop/ponastavitev**



**Izbira enot/nastavitvev**



**Nastavljanje vrednosti navora navzgor**



**Nastavljanje vrednosti navora navzdol**

### **1. KORAK: IZBIRA ENOT**



Izbrana enota: N·m

↓ Pritisnite 



Izbrana enota: in·lb

↓ Pritisnite 



Izbrana enota: ft·lb

↓ Pritisnite 



Izbrana enota: kg·cm

## 2. KORAK: NASTAVITEV CILJNE VREDNOSTI MOMENTA



## 3. KORAK: NAČIN DELOVANJA PEAK/TRACK

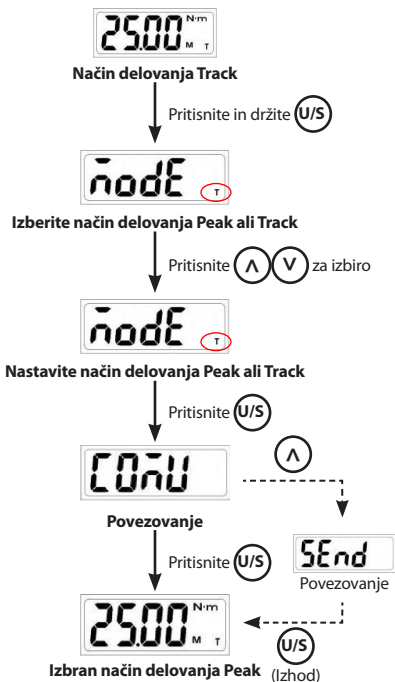

### OPOZORILO:

Komuniciranje je namenjeno zgolj za kalibracijo elektronskega momentnega ključa. Za več informacij o kalibraciji kontaktirajte vašega prodajalca.

## NAČIN DELOVANJA TRACK

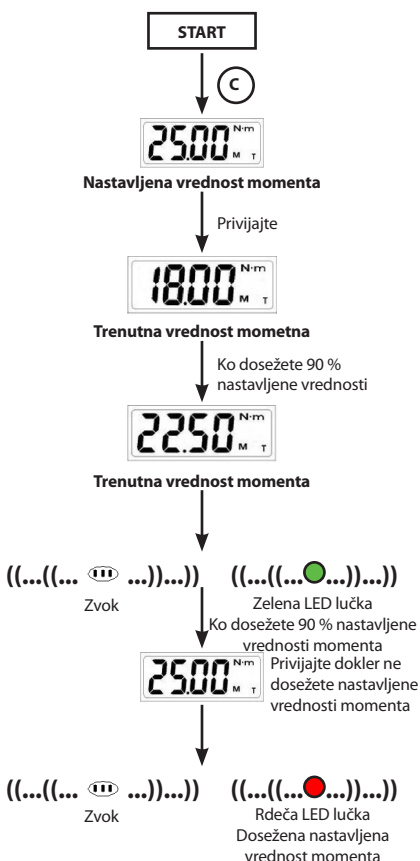

### POMEMBNO:

1. Če se na ekranu pojavi , to pomeni da je bil moment apliciran na ključ večji od 110%, maksimalnega momenta ključa.
2. Ko dosežete 90 % nastavljene vrednosti momenta bo začela utripati zelena LED lučka, hkrati pa boste zaslišali tudi prekinjajoč zvočni signal.
3. Ko dosežete 99,5 % nastavljene vrednosti momenta se sproži neprekinjen zvočni signal, zelena LED lučka bo svetila neprekinjeno, prižgala pa se bo tudi rdeča LED lučka.

## NAČIN DELOVANJA PEAK



### POMEMBNO:

1. Če se na ekranu pojavi **Er0**, to pomeni da je bil moment apliciran na ključ večji od 110 % maksimalnega momenta ključa.
2. Ko dosežete 90 % nastavljene vrednosti momenta bo začela utripati zelena LED lučka, hkrati pa boste zaslišali tudi prekinjajoč zvočni signal.
3. Ko dosežete 99,5 % nastavljene vrednosti momenta se sproži neprekinjen zvočni signal, zelena LED lučka bo svetila neprekinjeno, prižgala pa se bo tudi rdeča LED lučka.

### VZDRŽEVANJE IN SHRANJEVANJE

#### OPOZORILO:

Za ohranjanje natančnosti momentnega ključa je treba ključ enkrat letno kalibrirati.  
Več informacij o kalibraciji boste dobili pri svojem trgovcu.







**For calibration and  
repair service, visit**



**Unior d.d.**  
Kovaška cesta 10  
3214 Zreče, Slovenia  
T: +386 3 757 81 00  
[www.uniorbiketools.com](http://www.uniorbiketools.com)