

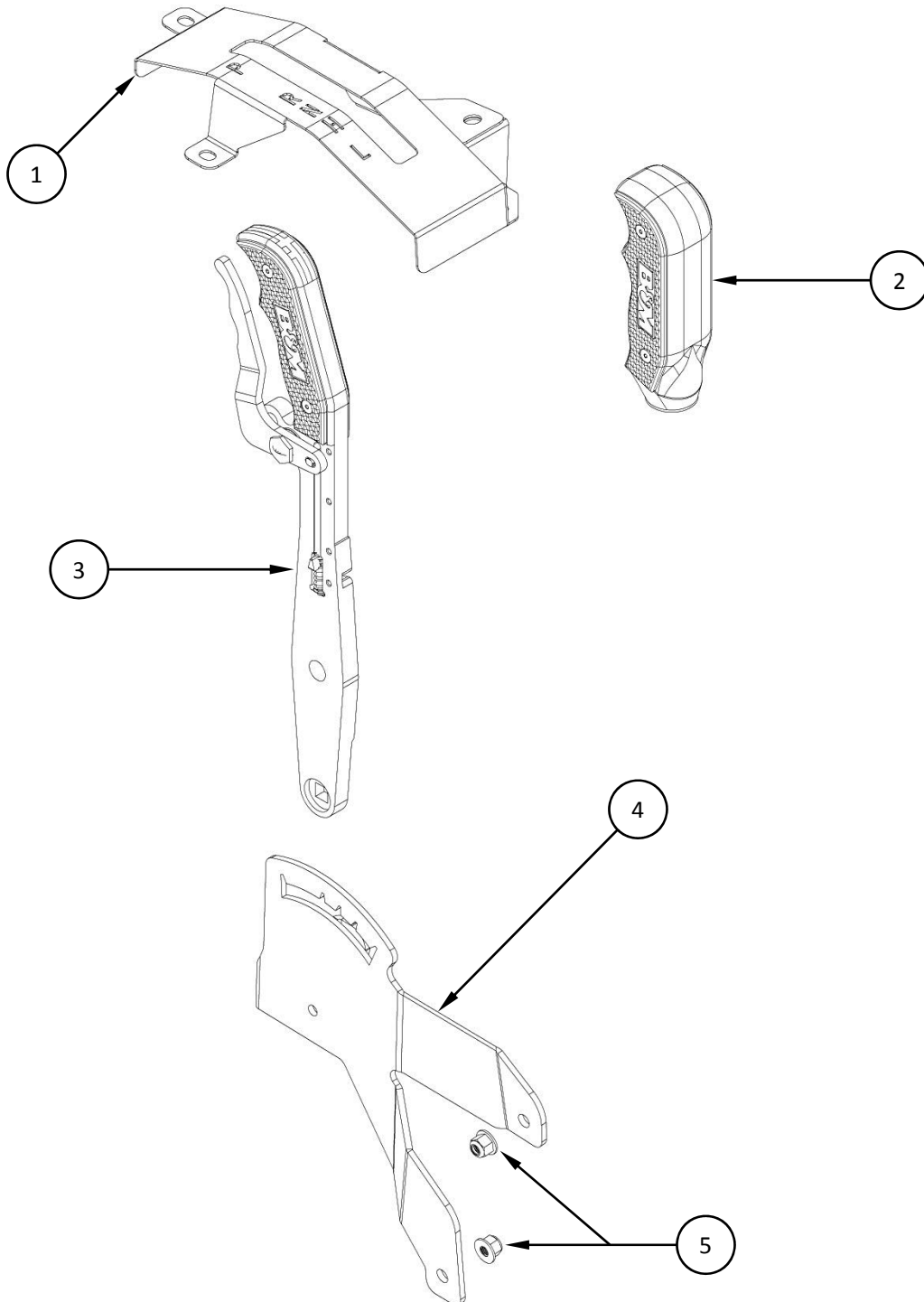

Installation Diagram
81149
**MAGNUM GRIP GATED SHIFTER &
PASSENGER GRAB HANDLE**
2017-21 CAN-AM MAVERICK X3





Installation Instructions
81149
MAGNUM GRIP GATED SHIFTER &
PASSENGER GRAB HANDLE
2017-19 CAN-AM MAVERICK X3

PARTS LIST

ITEM NO.	PART NO.	DESCRIPTION	QTY.
1	4101369	COVER, DUST	1
2	N/A - SHIPS ASSEMBLED	PASSENGER GRAB HANDLE ASSY	1
N/A	4001753	• MAGNUM GRIP GRAB HANDLE BODY	1
	4001492	• MAGNUM GRIP SIDE PLATE, LEFT, DIAMOND KNURL, BLACK	1
	4001495	• MAGNUM GRIP SIDE PLATE, RIGHT, DIAMOND KNURL, BLACK	1
	3401545	• SET SCREW, CUP POINT, 10-32 × 3/16", 18-8 SS	8
	3401549	• SCREW, 6-32 × 1/4" FLAT SOCKET HEAD	4
3	N/A - SHIPS ASSEMBLED	SHIFT LEVER ASSY, 17-18 CAN-AM MAVERICK X3	1
N/A	3400533	• WASHER, CURVED SPRING, #U375-0100S	1
	3401537	• SCREW, 6-32 × 5/16" FLAT SOCKET HEAD	4
	3401559	• PIN, DOWEL M5 × 18MM MCM #91585A553	1
	4001393	• BOLT, SHOULDER CHROME	1
	4001482	• LEVER, BLACK ANODIZED, MAGNUM GRIP SHIFTERS	1
	4001492	• MAGNUM GRIP SIDE PLATE, LEFT, DIAMOND KNURL, BLACK	1
	4001495	• MAGNUM GRIP SIDE PLATE, RIGHT, DIAMOND KNURL, BLACK	1
	4001497	• SPRING, SELECTOR	1
	4001740	• PIN, SELECTOR STOP	1
4001748	• STICK, MAG GRP GTD SHIFTER	1	
4	4001749	GATE PLATE	1
5	3401567	NUT, M6 FLANGED NYLOCK ZINC COATED	2

Before starting, take a moment to read and understand these instructions for your B&M Magnum Grip Gated Shifter. Use the parts drawing and list to verify your kit's contents. In the unlikely event of missing parts, please contact B&M Technical Support for replacements.

We highly recommend that you retain all factory parts.

REMOVE THE STOCK SHIFTER AND GRAB HANDLE:

1. Securely chock the vehicle's wheels to keep it from rolling when the shift lever is manipulated.



2. Loosen the jam nut and remove the shift knob.



3. Remove the screw and the passenger grab handle (twist back and forth while pulling).

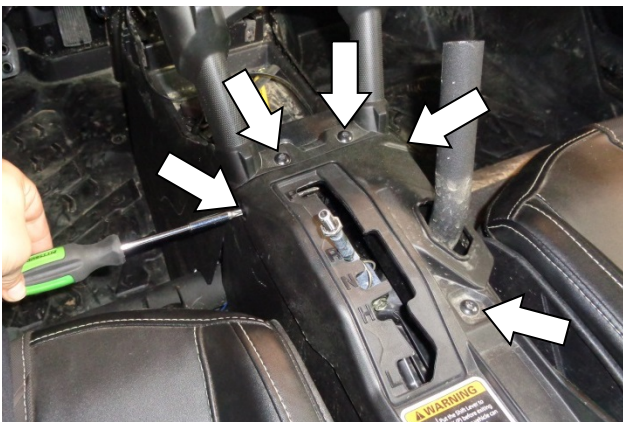

4. Remove the 5 screws shown.

2-SEAT MODELS:



5. Remove the 2 push rivets. **THEN GO TO STEP 15.**

4-SEAT MODELS:

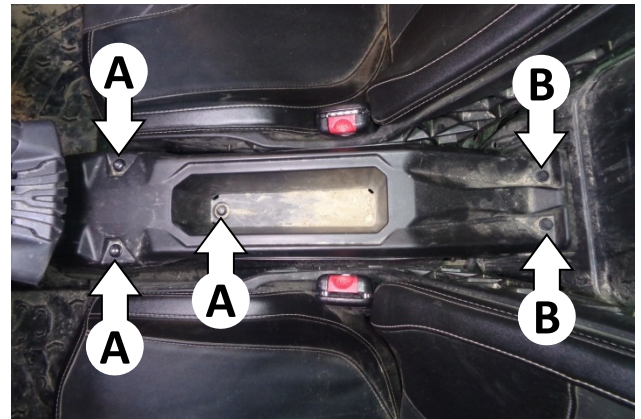

6. Slide both front seats fully forward. At the rear console cover, remove 3 screws (A) and 2 plastic push rivets (B).



7. Carefully unsnap the clip securing the rear of each rear side panel (2 places – left and right panels) to the rear console cover.



8. Remove rear console cover.

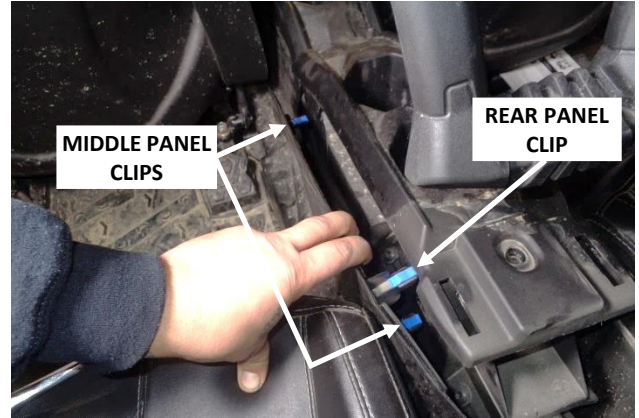

11. Carefully unsnap the 3 clips shown: 2 clips on each middle side panel; and 1 clip at the front of each rear side panel. Remove both middle side panels.



9. Gain access to the 3 screws securing the front of the middle console cover as follows (**Steps 10-13**).

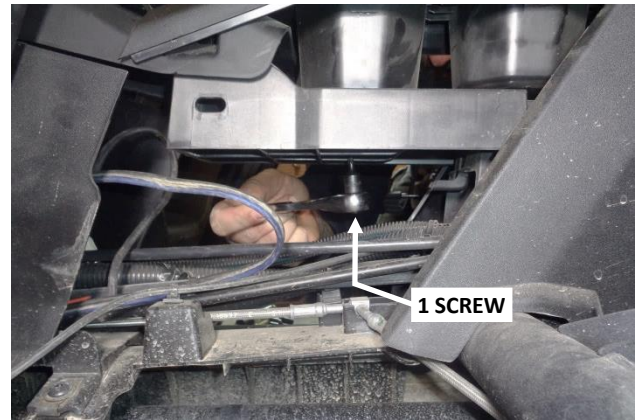

12. Under the front cup holder in the middle console cover, remove the 1 screw.

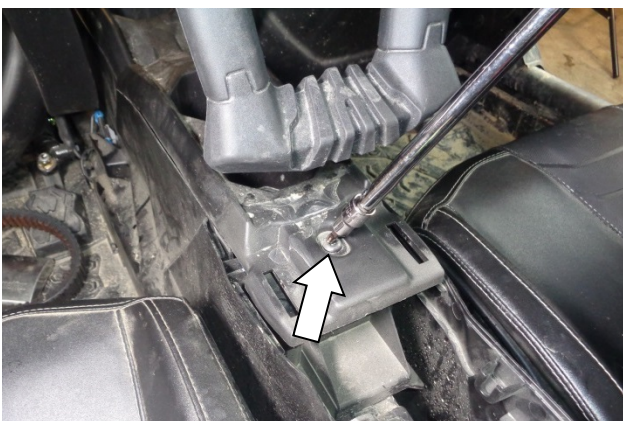

10. Remove the screw at the rear of the middle console cover.



13. Forward of the first screw, remove the other 2 screws.



14. Remove middle console cover.

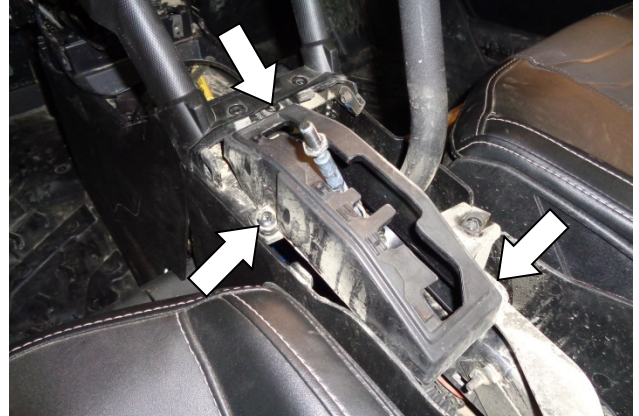

17. Remove the 3 screws shown, then remove the shifter gate.

ALL MODELS:



15. Carefully unsnap the 3 clips on each front side panels. Then remove front console cover.



18. Remove the nut plate from right side of the shifter gate for use at **Step 39**.



16. Remove both front side panels.



19. Remove the nut and washer connecting the shift lever to the cable. (Only the nut will be reused at **Step 32**.)

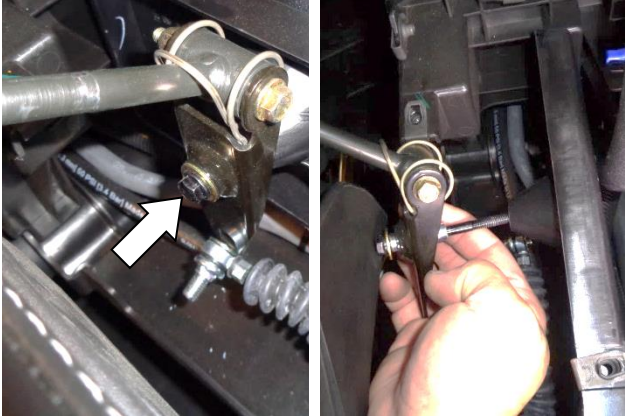

20. Remove the shift lever pivot screw, nut and washers, then remove the shift lever. (All hardware will be reused at **Step 35.**)



21. Remove the pivot bushing for use at **Step 31.**



22. Remove 2 plastic sleeves from shifter for use at **Step 30.**



23. Remove the screw, nut and washer securing the grab handle tube to the frame. (Only the screw and nut will be reused at **Step 36.**)

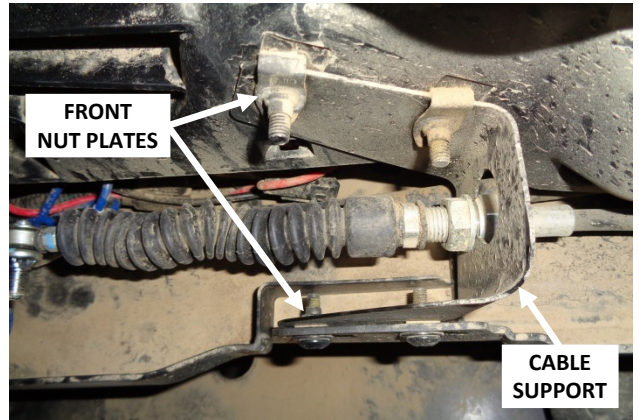

24. Remove the 2 nut plates at the front of the shift cable support as follows (**Steps 25-28.**)

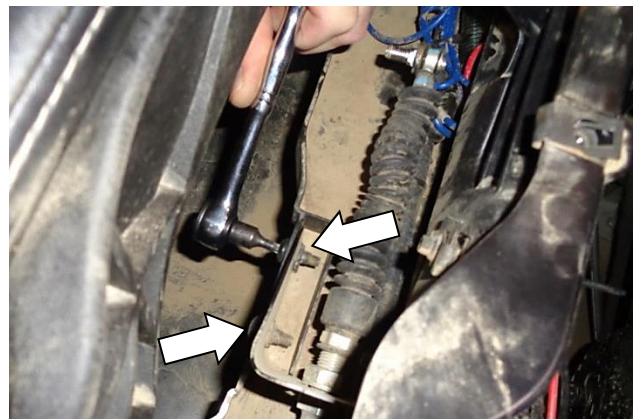

25. Remove the 2 screws securing the left side of the cable support.

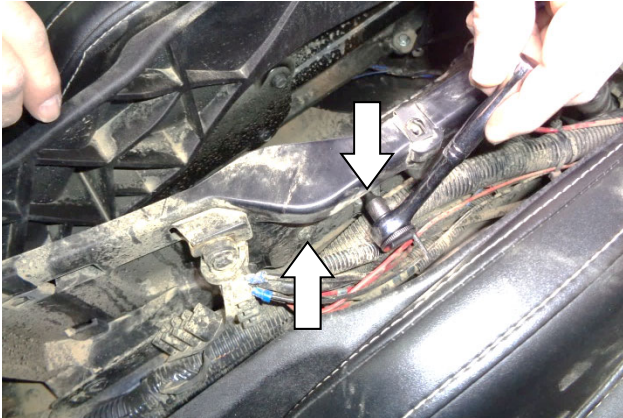

26. Remove the 2 screws securing the right side of the cable support.



29. Reinstall the cable support in the frame. Hand-start (do not tighten) only the 2 rear screws. (The other 2 screws will be used at **Step 35.**)

INSTALL YOUR B&M GATED SHIFTER AND GRAB HANDLE:



27. Lift the cable support out of the frame.



30. Install the 2 plastic sleeves in the shift lever assembly (3).

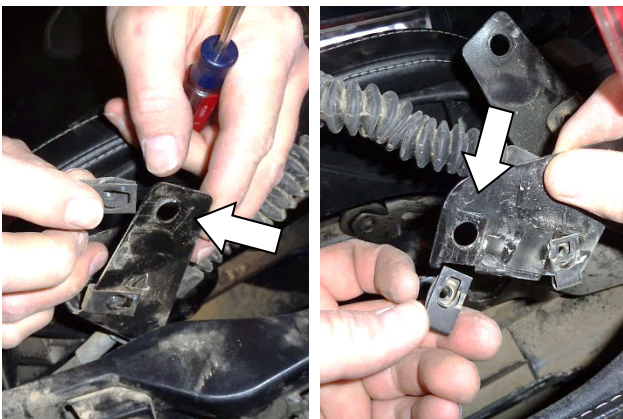

28. Remove the 2 nut plates at the front of the shifter support.



31. Install the pivot bushing in the pivot bore in the frame.

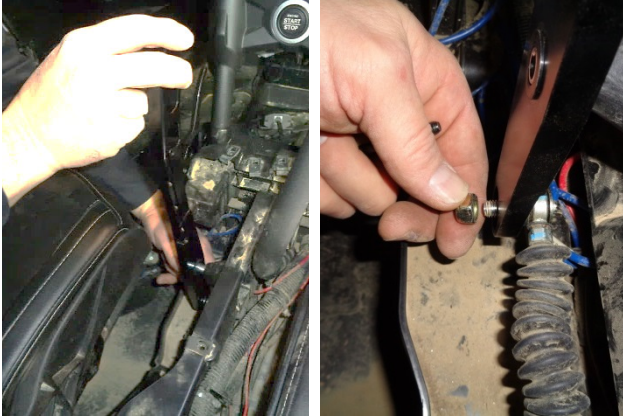

32. Install the shift lever assembly and hand-start (do not tighten) the cable end nut.



33. Put the gate plate (4) in place.

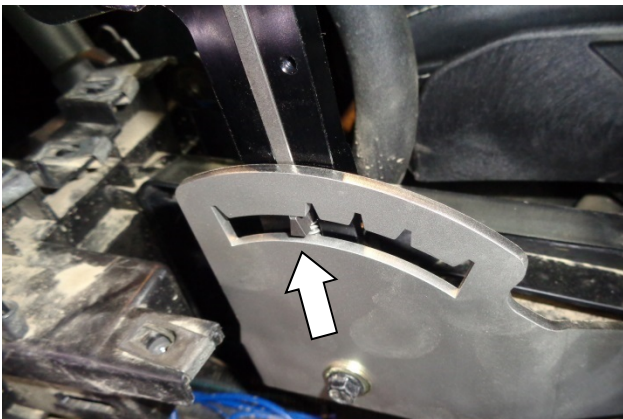

34. NOTE: When the gate plate hardware is installed in the next step, do not be concerned if the selector stop pin does not fall into the notch that corresponds to the transmission's current position. The shift cable will be adjusted later.

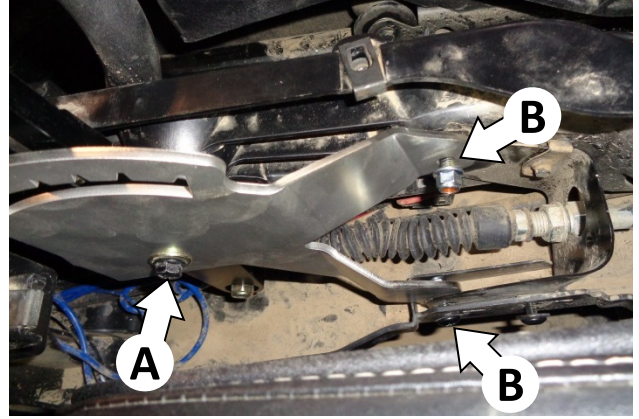

35. Hand-start (do not tighten) the pivot screw, nut and washers (A), and the front cable support screws and nuts (5) (B).

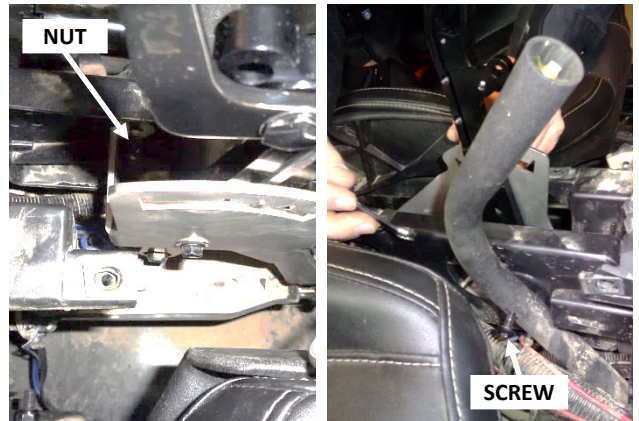

36. Install the front gate plate screw from the passenger side, and hand-start (do not tighten) the nut.

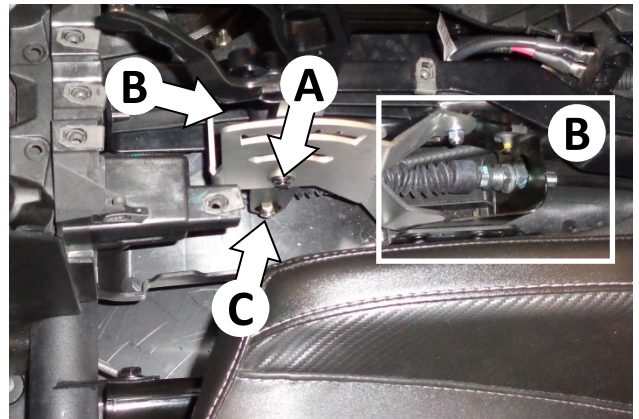

37. Tighten the shifter hardware in the following order: pivot screw (A); shifter gate and cable support screws (5 places; B); and cable end nut (C).



38. Remove the shoulder bolt, locking lever and spring washer. **NOTE: Do not lose the spring washer (located under the bolt head).**

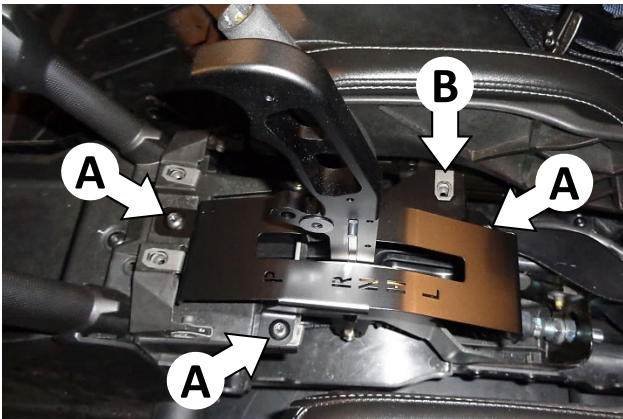

39. Install the dust cover (1) and secure with stock screws (A). Then install the nut plate (B) removed at Step 18.



40. Reinstall the locking lever, spring washer and bolt. Ensure that the lever's short leg properly engages the selector pin.

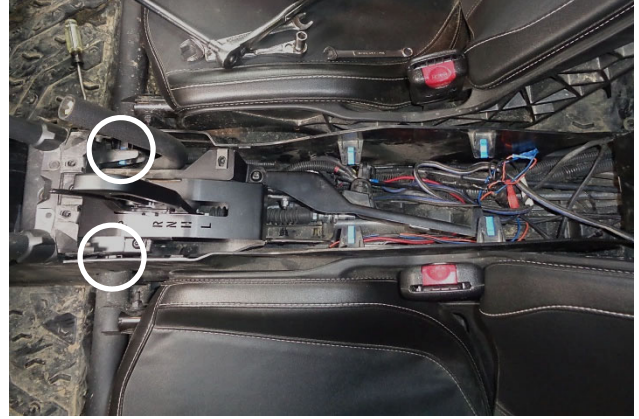

41. Reinstall both front side panels. Place the front clips loosely in their slots, but do not snap them into place yet.

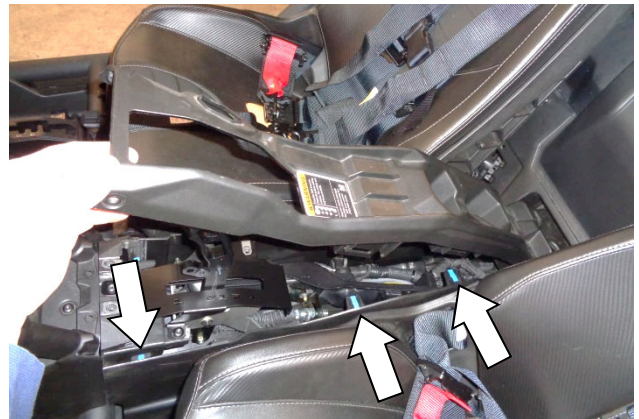

42. Install the front console cover. Then snap the 3 clips on each side panel into place.



43. Install the 5 screws as shown.

4-SEAT MODELS:



44. Put the middle console cover in place, and hand-start (do not tighten) the rear screw.

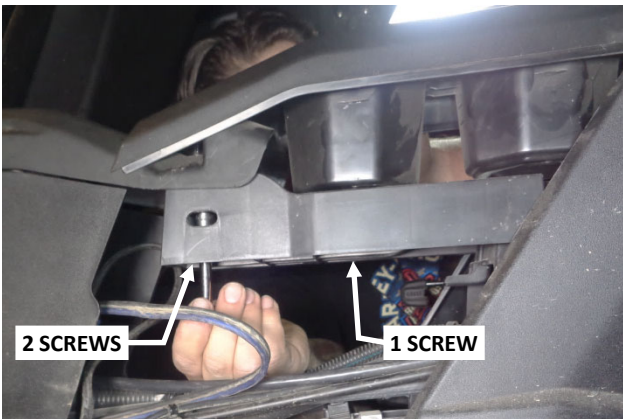

45. From underneath the middle console, install the 3 front screws.

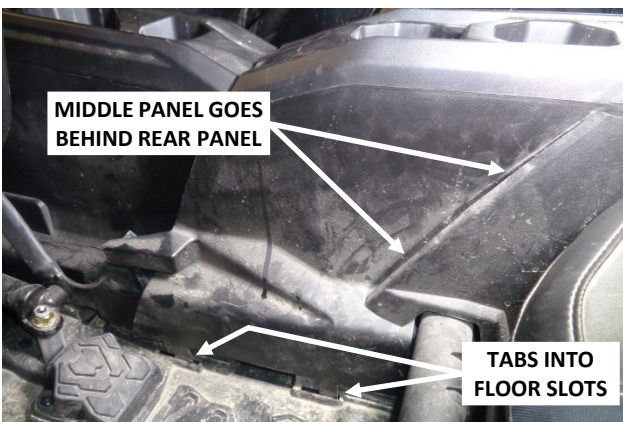

46. Install the middle side panels, slipping them under the rear panels, and inserting the 2 tabs into the slots in the floor.

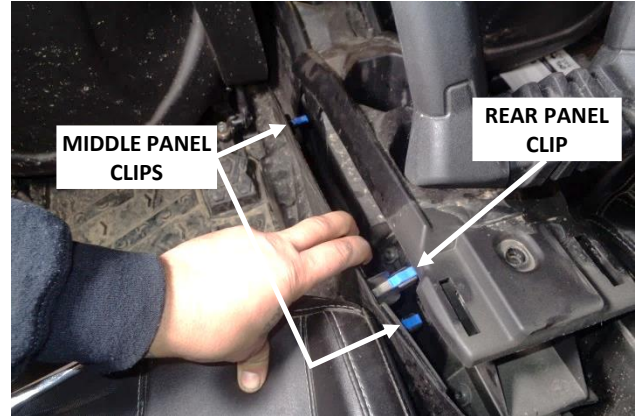

47. Snap the 3 clips shown into their slots: 2 clips on each middle side panel; and 1 clip at the front of each rear side panel.

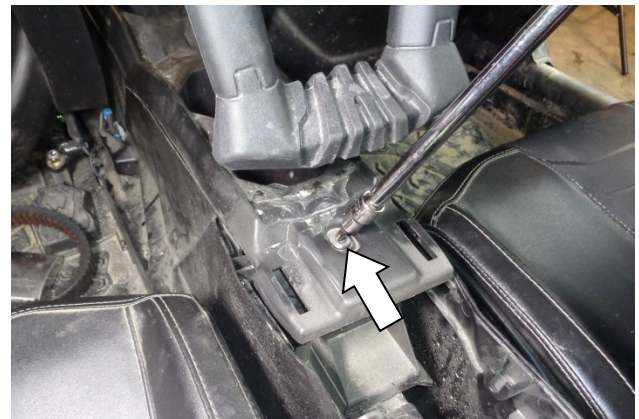

48. Tighten the screw at the rear of the middle console cover.



49. Install the rear console cover, aligning pins with their notches, and snapping the clips into their slots.

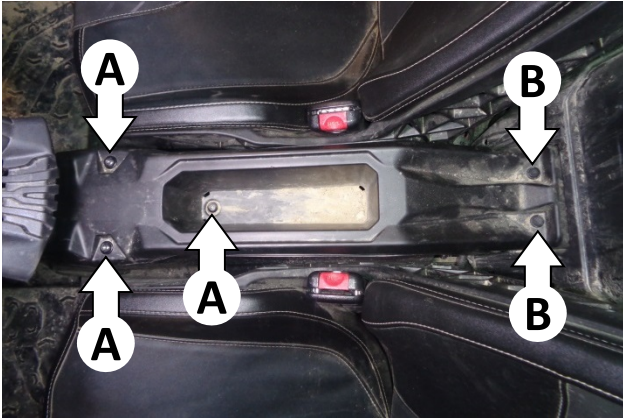

50. Secure the rear console cover with its 3 screws (A) and 2 plastic push rivets (B).

2-SEAT MODELS:



51. Secure rear of the console cover with its 2 plastic push rivets.

ALL MODELS:



52. Remove the two side plates from the passenger grab handle assembly (2), then back out the 8 set screws sufficiently to permit the handle to fully slide onto the handle frame.



53. Slip the passenger grab handle onto the tube, align it as desired, and tighten the 8 set screws.



54. Reinstall the grab handle side plates.

ADJUST THE SHIFT CABLE:



55. Lock the shift handle in LOW.

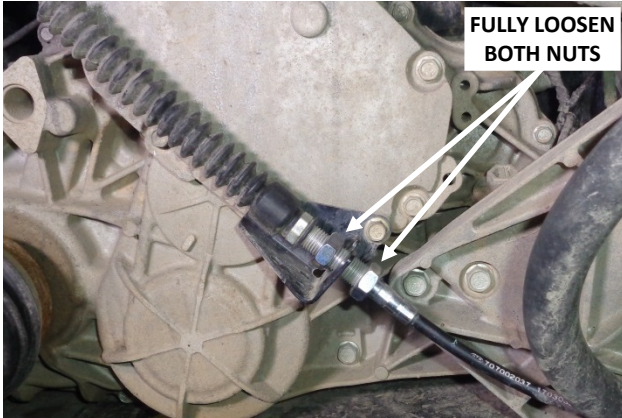

56. At the engine-end of the shift cable, fully loosen both jam nuts, so that they are not touching the cable bracket.



57. Manually verify that the shift arm is rotated fully forward.



58. Turn both nuts back by hand until they are equally snug against the cable bracket.



59. Tighten both nuts against the bracket.

Shift up and down through the gears a few times. The shift lever should move freely without restriction (except for a slight spring load going into PARK).

Start the engine and shift through the gear range to verify the transmission shifts into every gear.

WARNING: After adjustment, verify that the PARK position works properly.

Congratulations, the installation of your B&M Magnum Grip Gated Shifter and Passenger Grab Handle is now complete!

IMPORTANT: RETAIN THESE INSTRUCTIONS FOR FUTURE REFERENCE

